



НАСОСНОЕ ОБОРУДОВАНИЕ

Прайс лист, версия 11.07.2022

№ Лист		№ стр.
1	CDM, CDMF вертикальные многоступенчатые насосы НОВАЯ СЕРИЯ	2
2	CDLF, CDL вертикальные многоступенчатые насосы	8
3	CDLK, CDLKF полупогружные многоступенчатые насосы	16
4	CHL, CHLF, CHLFT горизонтальные многоступенчатые центробежные насосы	22
5	CHM горизонтальные многоступенчатые центробежные насосы	26
6	TD+TD G одноступенчатые циркуляционные насосы типа "ин-лайн"	28
7	CMS(L) Циркуляционные насосы с "мокрым ротором"	32
8	SJ многоступенчатые погружные насосы из нержавеющей стали	33
9	SM многоступенчатые погружные насосы из нержавеющей стали (пластиковое рабочее колесо)	40
10	WQ погружные насосы для отвода канализационных сточных вод	43
11	WQ-X погружные насосы (Vortex колесо) для отвода канализационных сточных вод	49
12	WQ-W погружные насосы с режущим механизмом для отвода канализационных сточных вод	50
13	WQ-D погружные однофазные электронасосы для отвода канализационных сточных вод	52
14	WQ-H погружные электронасосы WQ H для отвода канализационных сточных вод	53
15	WQ-QG погружные насосы с режущим механизмом для отвода канализационных сточных вод	55
16	Принадлежности для насосов WQ (автоматические муфты, поплавки)	56
17	SDS Погружные дренажные насосы	58
18	NES консольно-моноблочные насосы по стандарту EN733	59
19	NESO консольные насосы по стандарту EN733	62
20	SMM консольно-моноблочные насосы по стандарту ISO2858	65
21	NIS центробежные консольно-моноблочные насосы по стандарту DIN 24256	67
22	NISO центробежные консольные насосы по стандарту DIN 24256	75
23	ZS центробежные моноблочные штампованные насосы	79
24	MS горизонтальные одноступенчатые центробежные насосы из нержавеющей стали	80
25	SZ горизонтальные одноступенчатые фторопластовые центробежные насосы	81
26	WLT высокоэффективные высокорасходные насосы	82
27	SP самовсасывающие поверхностные насосы для отвода загрязненных сточных вод	83
28	QY/QYL — Самовсасывающие вихревые насосы-ФЛОТАТОРЫ из нержавеющей стали	85
	50HZ	
29	Трехфазные асинхронные двигатели (низковольтные)	86
30	Контроллеры с функцией частотного преобразования, датчики	91
31	Запорная арматура Aikon	94



НОВИНКА!!! CDMF, CDM вертикальные многоступенчатые насосы (с двигателями IE3 от 0,75кВт!!!)

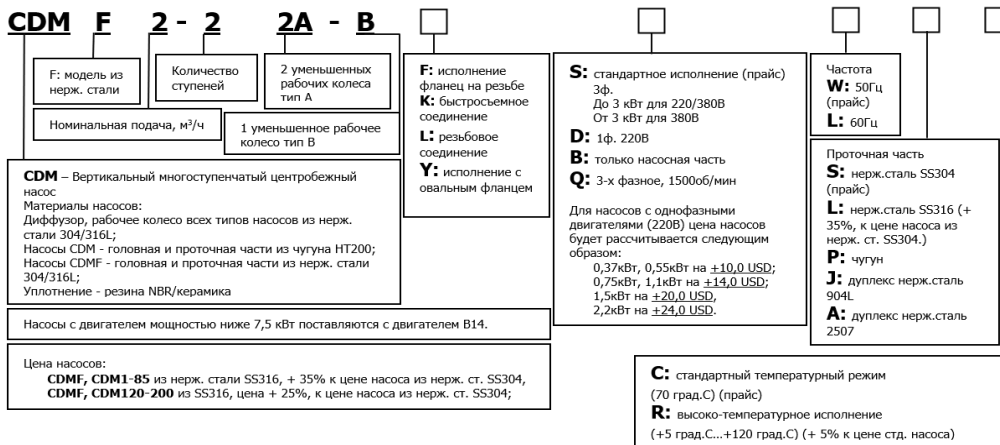

Установка датчиков РТС в обмотки электродвигателя с питающим напряжением 3х380В 50 Гц +41\$ к розничной цене.

обновление 08.07.2022

Входная, выходная камеры - чугун CI		Входная, выходная камеры -нерж. SS304		Мощность (кВт)	Заменяемая модель CDLF, CDL
Модель/арт. CDM	Цена розница (USD) с НДС	Модель/арт. CDMF	Цена розница (USD) с НДС		
CDMF, CDM1					
CDM1-2FSWPC IE2	335.70	CDMF1-2FSWSC IE2	415.65	0.37	CDLF, CDL 1-2
CDM1-3FSWPC IE2	414.20	CDMF1-3FSWSC IE2	493.44	0.37	CDLF, CDL 1-3
CDM1-4FSWPC IE2	439.99	CDMF1-4FSWSC IE2	519.97	0.37	CDLF, CDL 1-4
CDM1-5FSWPC IE2	486.78	CDMF1-5FSWSC IE2	566.76	0.37	CDLF, CDL 1-5
CDM1-6FSWPC IE2	543.54	CDMF1-6FSWSC IE2	623.88	0.37	CDLF, CDL 1-6
CDM1-7FSWPC IE2	580.76	CDMF1-7FSWSC IE2	660.00	0.37	CDLF, CDL 1-7
CDM1-8FSWPC IE2	622.04	CDMF1-8FSWSC IE2	701.99	0.55	CDLF, CDL 1-8
CDM1-9FSWPC IE2	642.68	CDMF1-9FSWSC IE2	722.63	0.55	CDLF, CDL 1-9
CDM1-10FSWPC IE2	673.62	CDMF1-10FSWSC IE2	753.57	0.55	CDLF, CDL 1-10
CDM1-11FSWPC IE2	720.44	CDMF1-11FSWSC IE2	800.00	0.55	CDLF, CDL 1-11
CDM1-12FSWPC	763.61	CDMF1-12FSWSC	843.47	0.75	CDLF, CDL 1-12
CDM1-13FSWPC	779.19	CDMF1-13FSWSC	859.43	0.75	CDLF, CDL 1-13
CDM1-14FSWPC	806.19	CDMF1-14FSWSC	885.22	0.75	CDLF, CDL 1-14
CDM1-15FSWPC	821.35	CDMF1-15FSWSC	900.77	0.75	CDLF, CDL 1-15
CDM1-16FSWPC	838.14	CDMF1-16FSWSC	917.97	1.1	CDLF, CDL 1-16
CDM1-17FSWPC	844.27	CDMF1-17FSWSC	924.52	1.1	CDLF, CDL 1-17
CDM1-18FSWPC	856.56	CDMF1-18FSWSC	936.39	1.1	CDLF, CDL 1-18
CDM1-19FSWPC	912.64	CDMF1-19FSWSC	992.51	1.1	CDLF, CDL 1-19
CDM1-20FSWPC	933.55	CDMF1-20FSWSC	1 013.38	1.1	CDLF, CDL 1-20

CDM1-21FSWPC	954.43	CDMF1-21FSWSC	1 033.84	1.1	CDLF, CDL 1-21
CDM1-22FSWPC	992.92	CDMF1-22FSWSC	1 050.63	1.1	CDLF, CDL 1-22
CDM1-23FSWPC	1 083.80	CDMF1-23FSWSC	1 163.66	1.5	CDLF, CDL 1-23
CDM1-24FSWPC	1 093.63	CDMF1-24FSWSC	1 173.87	1.5	CDLF, CDL 1-24
CDM1-25FSWPC	1 103.87	CDMF1-25FSWSC	1 184.12	1.5	CDLF, CDL 1-25
CDM1-26FSWPC	1 121.46	CDMF1-26FSWSC	1 200.91	1.5	CDLF, CDL 1-26
CDM1-27FSWPC	1 137.84	CDMF1-27FSWSC	1 218.11	1.5	CDLF, CDL 1-27
CDM1-28FSWPC	1 146.87	CDMF1-28FSWSC	1 225.87	1.5	CDLF, CDL 1-28
CDM1-29FSWPC	1 154.63	CDMF1-29FSWSC	1 233.66	1.5	CDLF, CDL 1-29
CDM1-30FSWPC	1 163.24	CDMF1-30FSWSC	1 243.07	1.5	CDLF, CDL 1-30
CDM1-31FSWPC	1 274.20	CDMF1-31FSWSC	1 353.61	2.2	CDLF, CDL 1-31
CDM1-32FSWPC	1 386.39	CDMF1-32FSWSC	1 465.39	2.2	CDLF, CDL 1-32
CDM1-33FSWPC	1 498.56	CDMF1-33FSWSC	1 577.59	2.2	CDLF, CDL 1-33
CDM1-34FSWPC	1 525.18	CDMF1-34FSWSC	1 605.43	2.2	CDLF, CDL 1-34
CDM1-35FSWPC	1 553.84	CDMF1-35FSWSC	1 632.05	2.2	CDLF, CDL 1-35
CDM1-36FSWPC	1 580.46	CDMF1-36FSWSC	1 659.88	2.2	CDLF, CDL 1-36
CDM1-37FSWPC	1 607.50	CDMF1-37FSWSC	1 687.33	2.2	--
CDM1-38FSWPC	1 635.33	CDMF1-38FSWSC	1 714.34	2.2	--
CDM1-39FSWPC	1 662.34	CDMF1-39FSWSC	1 742.20	2.2	--
CDM1-40FSWPC	1 689.37	CDMF1-40FSWSC	1 769.20	2.2	--
CDMF, CDM3					
CDM3-2FSWPC IE2	369.61	CDMF3-2FSWSC IE2	449.20	0.37	CDLF, CDL 2-2; 3-2
CDM3-3FSWPC IE2	418.61	CDMF3-3FSWSC IE2	498.59	0.37	CDLF, CDL 2-3; 3-3
CDM3-4FSWPC IE2	468.00	CDMF3-4FSWSC IE2	548.34	0.37	CDLF, CDL 3-4; 3-5
CDM3-5FSWPC IE2	487.55	CDMF3-5FSWSC IE2	567.11	0.55	CDLF, CDL 2-4; 3-6
CDM3-6FSWPC IE2	514.43	CDMF3-6FSWSC IE2	594.41	0.55	CDLF, CDL 2-5; 3-7
CDM3-7FSWPC	596.58	CDMF3-7FSWSC	676.82	0.75	CDLF, CDL 2-6; 3-8; 3-9
CDM3-8FSWPC	624.41	CDMF3-8FSWSC	704.24	0.75	CDLF, CDL 2-7; 3-10
CDM3-9FSWPC	655.53	CDMF3-9FSWSC	734.95	1.1	CDLF, CDL 2-8; 3-11
CDM3-10FSWPC	673.95	CDMF3-10FSWSC	753.78	1.1	CDLF, CDL 2-9; 3-12; 3-13
CDM3-11FSWPC	718.16	CDMF3-11FSWSC	797.60	1.1	CDLF, CDL 2-10; 3-14
CDM3-12FSWPC	761.57	CDMF3-12FSWSC	841.40	1.1	CDLF, CDL 2-11; 3-15
CDM3-13FSWPC	810.28	CDMF3-13FSWSC	890.14	1.5	CDLF, CDL 2-12; 3-16
CDM3-14FSWPC	822.57	CDMF3-14FSWSC	901.60	1.5	CDLF, CDL 2-13; 3-17; 3-18
CDM3-15FSWPC	842.64	CDMF3-15FSWSC	922.47	1.5	CDLF, CDL 2-14; 3-19
CDM3-16FSWPC	863.10	CDMF3-16FSWSC	942.55	1.5	CDLF, CDL 2-15; 3-20; 3-21
CDM3-17FSWPC	881.14	CDMF3-17FSWSC	961.38	2.2	CDLF, CDL 2-16; 3-22
CDM3-18FSWPC	895.06	CDMF3-18FSWSC	975.30	2.2	CDLF, CDL 2-17; 3-23
CDM3-19FSWPC	909.39	CDMF3-19FSWSC	989.22	2.2	CDLF, CDL 3-24; 3-25
CDM3-20FSWPC	922.89	CDMF3-20FSWSC	1 002.72	2.2	CDLF, CDL 2-18; 3-26
CDM3-21FSWPC	968.76	CDMF3-21FSWSC	1 049.00	2.2	CDLF, CDL 2-19; 3-27; 3-28
CDM3-22FSWPC	997.42	CDMF3-22FSWSC	1 076.42	2.2	CDLF, CDL 2-20; 3-29
CDM3-23FSWPC	1 024.01	CDMF3-23FSWSC	1 104.29	2.2	CDLF, CDL 2-21; 3-30
CDM3-24FSWPC	1 051.05	CDMF3-24FSWSC	1 130.88	2.2	CDLF, CDL 2-22; 3-31; 3-32
CDM3-25FSWPC	1 085.04	CDMF3-25FSWSC	1 164.46	3	CDLF, CDL 2-23; 3-33
CDM3-26FSWPC	1 105.50	CDMF3-26FSWSC	1 184.53	3	CDLF, CDL 2-24; 3-34
CDM3-27FSWPC	1 125.58	CDMF3-27FSWSC	1 204.99	3	CDLF, CDL 2-25; 3-35
CDM3-28FSWPC	1 146.04	CDMF3-28FSWSC	1 225.07	3	CDLF, CDL 3-36
CDM3-29FSWPC	1 166.12	CDMF3-29FSWSC	1 245.53	3	CDLF, CDL 2-26
CDM3-30FSWPC	1 186.58	CDMF3-30FSWSC	1 265.61	3	--
CDM3-31FSWPC	1 206.62	CDMF3-31FSWSC	1 286.07	3	--
CDMF, CDM5					
CDM5-2FSWPC IE2	377.96	CDMF5-2FSWPC IE2	455.80	0.37	--
CDM5-3FSWPC IE2	429.51	CDMF5-3FSWPC IE2	506.88	0.55	CDLF, CDL 4-2
CDM5-4FSWPC IE2	479.05	CDMF5-4FSWPC IE2	556.42	0.55	CDLF, CDL 4-3
CDM5-5FSWPC	520.42	CDMF5-5FSWSC	597.79	0.75	CDLF, CDL 4-4

CDM5-6FSWPC	591.66	CDMF5-6FSWSC	669.45	1.1	CDLF, CDL 4-5
CDM5-7FSWPC	610.91	CDMF5-7FSWSC	689.11	1.1	--
CDM5-8FSWPC	642.83	CDMF5-8FSWSC	720.62	1.1	CDLF, CDL 4-6
CDM5-9FSWPC	676.41	CDMF5-9FSWSC	754.61	1.5	CDLF, CDL 4-7
CDM5-10FSWPC	738.23	CDMF5-10FSWSC	816.44	1.5	CDLF, CDL 4-8
CDM5-11FSWPC	768.94	CDMF5-11FSWSC	846.73	1.5	CDLF, CDL 4-9
CDM5-12FSWPC	812.74	CDMF5-12FSWSC	891.35	2.2	CDLF, CDL 4-10
CDM5-13FSWPC	825.02	CDMF5-13FSWSC	902.81	2.2	CDLF, CDL 4-11
CDM5-14FSWPC	837.31	CDMF5-14FSWSC	915.52	2.2	--
CDM5-15FSWPC	849.60	CDMF5-15FSWSC	927.39	2.2	CDLF, CDL 4-12
CDM5-16FSWPC	867.61	CDMF5-16FSWSC	945.42	2.2	CDLF, CDL 4-13
CDM5-17FSWPC	992.09	CDMF5-17FSWSC	1 070.29	3	CDLF, CDL 4-14
CDM5-18FSWPC	1 011.34	CDMF5-18FSWSC	1 089.96	3	CDLF, CDL 4-15
CDM5-19FSWPC	1 030.59	CDMF5-19FSWSC	1 108.79	3	--
CDM5-20FSWPC	1 050.22	CDMF5-20FSWSC	1 128.04	3	CDLF, CDL 4-16
CDM5-21FSWPC	1 143.58	CDMF5-21FSWSC	1 221.37	3	CDLF, CDL 4-17
CDM5-22FSWPC	1 295.07	CDMF5-22FSWSC	1 373.27	4	CDLF, CDL 4-18
CDM5-23FSWPC	1 337.65	CDMF5-23FSWSC	1 415.06	4	CDLF, CDL 4-19
CDM5-24FSWPC	1 379.43	CDMF5-24FSWSC	1 457.22	4	CDLF, CDL 4-20
CDM5-25FSWPC	1 422.01	CDMF5-25FSWSC	1 499.39	4	--
CDM5-26FSWPC	1 463.77	CDMF5-26FSWSC	1 541.55	4	CDLF, CDL 4-21
CDM5-27FSWPC	1 505.93	CDMF5-27FSWSC	1 583.34	4	CDLF, CDL 4-22
CDM5-28FSWPC	1 548.13	CDMF5-28FSWSC	1 625.92	4	--
CDM5-29FSWPC	1 750.79	CDMF5-29FSWSC	1 828.16	5.5	--
CDM5-30FSWPC	1 792.57	CDMF5-30FSWSC	1 870.36	5.5	--
CDM5-31FSWPC	1 834.73	CDMF5-31FSWSC	1 912.52	5.5	--
CDM5-32FSWPC	1 876.90	CDMF5-32FSWSC	1 954.69	5.5	--
CDM5-33FSWPC	1 918.65	CDMF5-33FSWSC	1 996.06	5.5	--
CDMF, CDM10					
CDM10-1FSWPC	570.75	CDMF10-1FSWSC	721.86	0.75	CDLF, CDL 8-2/1; 10-1
CDM10-2FSWPC	597.79	CDMF10-2FSWSC	749.28	0.75	CDLF, CDL 8-2; 10-2
CDM10-3FSWPC	675.99	CDMF10-3FSWSC	827.07	1.1	CDLF, CDL 8-3; 10-3; 12-2
CDM10-4FSWPC	788.19	CDMF10-4FSWSC	939.68	1.5	CDLF, CDL 8-4; 10-4; 12-3
CDM10-5FSWPC	828.73	CDMF10-5FSWSC	979.80	2.2	CDLF, CDL 8-5; 10-5
CDM10-6FSWPC	891.35	CDMF10-6FSWSC	1 041.63	2.2	CDLF, CDL 8-6; 10-6; 12-4
CDM10-7FSWPC	1 055.13	CDMF10-7FSWSC	1 206.62	3	CDLF, CDL 10-7; 10-8; 12-5
CDM10-8FSWPC	1 167.33	CDMF10-8FSWSC	1 318.82	3	CDLF, CDL 8-8; 10-9; 12-6
CDM10-9FSWPC	1 236.94	CDMF10-9FSWSC	1 387.61	4	CDLF, CDL 8-9; 10-10
CDM10-10FSWPC	1 528.88	CDMF10-10FSWSC	1 680.37	4	CDLF, CDL 8-10; 8-11; 10-11; 12-7
CDM10-11FSWPC	1 656.21	CDMF10-11FSWSC	1 807.70	4	CDLF, CDL 8-12; 10-12; 12-8
CDM10-12FSWPC	1 823.66	CDMF10-12FSWSC	1 975.18	4.5	CDLF, CDL 8-13; 10-13; 12-9
CDM10-13FSWPC	2 051.31	CDMF10-13FSWSC	2 202.83	5.5	CDLF, CDL 8-14; 10-14
CDM10-14FSWPC	2 083.67	CDMF10-14FSWSC	2 233.92	5.5	CDLF, CDL 8-15; 10-15; 12-10
CDM10-15FSWPC	2 154.50	CDMF10-15FSWSC	2 305.99	5.5	CDLF, CDL 8-16; 10-16; 10-17; 12-11
CDM10-16FSWPC	2 292.08	CDMF10-16FSWSC	2 442.35	7.5	CDLF, CDL 8-17; 10-18; 12-12
CDM10-17FSWPC	2 348.99	CDMF10-17FSWSC	2 500.48	7.5	CDLF, CDL 8-18; 10-19; 12-13
CDM10-18FSWPC	2 414.11	CDMF10-18FSWSC	2 565.18	7.5	CDLF, CDL 8-19; 10-20; 12-14
CDM10-19FSWPC	2 469.36	CDMF10-19FSWSC	2 620.05	7.5	CDLF, CDL 8-20; 10-21
CDM10-20FSWPC	2 528.32	CDMF10-20FSWSC	2 679.01	7.5	CDLF, CDL 10-22; 12-15
CDM10-21FSWPC	2 586.89	CDMF10-21FSWSC	2 737.96	7.5	CDLF, CDL 12-16
CDM10-22FSWPC	3 017.19	CDMF10-22FSWSC	3 168.30	11	CDLF, CDL 12-17; 12-18
CDMF, CDM15					
CDM15-1FSWPC	814.81	CDMF15-1FSWSC	966.30	1.1	CDLF, CDL 15-1
CDM15-2FSWPC	917.97	CDMF15-2FSWSC	1 069.46	2.2	CDLF, CDL 15-2
CDM15-3FSWPC	1 136.62	CDMF15-3FSWSC	1 287.70	3	CDLF, CDL 15-3
CDM15-4FSWPC	1 313.90	CDMF15-4FSWSC	1 464.60	4	CDLF, CDL 15-4

CDM15-5FSWPC	1 603.38	CDMF15-5FSWSC	1 754.49	4	CDLF, CDL 15-5
CDM15-6FSWPC	1 699.62	CDMF15-6FSWSC	1 850.28	5.5	CDLF, CDL 15-6
CDM15-7FSWPC	1 754.07	CDMF15-7FSWSC	1 904.32	5.5	CDLF, CDL 15-7
CDM15-8FSWPC	1 909.24	CDMF15-8FSWSC	2 035.35	7.5	CDLF, CDL 15-8
CDM15-9FSWPC	1 976.81	CDMF15-9FSWSC	2 127.47	7.5	CDLF, CDL 15-9
CDM15-10FSWPC	2 277.33	CDMF15-10FSWSC	2 428.44	11	CDLF, CDL 15-10
CDM15-11FSWPC	2 418.61	CDMF15-11FSWSC	2 568.85	11	CDLF, CDL 15-11
CDM15-12FSWPC	2 651.56	CDMF15-12FSWSC	2 803.08	11	CDLF, CDL 15-12
CDM15-13FSWPC	2 743.29	CDMF15-13FSWSC	2 894.78	11	CDLF, CDL 15-13
CDM15-14FSWPC	2 835.83	CDMF15-14FSWSC	2 986.49	11	CDLF, CDL 15-14
CDM15-15FSWPC	2 996.32	CDMF15-15FSWSC	3 147.01	15	CDLF, CDL 15-15
CDM15-16FSWPC	3 174.43	CDMF15-16FSWSC	3 325.12	15	CDLF, CDL 15-16
CDM15-17FSWPC	3 289.50	CDMF15-17FSWSC	3 440.57	15	CDLF, CDL 15-17
CDM15-18FSWPC	3 404.54	CDMF15-18FSWSC	3 555.23	15	--
CDMF, CDM20					
CDM20-1FSWPC	1 009.68	CDMF20-1FSWSC	1 162.83	1.1	CDLF, CDL 20-1
CDM20-2FSWPC	1 173.07	CDMF20-2FSWSC	1 374.93	2.2	CDLF, CDL 20-2
CDM20-3FSWPC	1 555.47	CDMF20-3FSWSC	1 732.78	4	CDLF, CDL 20-3
CDM20-4FSWPC	1 871.57	CDMF20-4FSWSC	2 049.68	5.5	CDLF, CDL 20-4
CDM20-5FSWPC	1 982.94	CDMF20-5FSWSC	2 160.25	5.5	CDLF, CDL 20-5
CDM20-6FSWPC	2 247.45	CDMF20-6FSWSC	2 425.98	7.5	CDLF, CDL 20-6
CDM20-7FSWPC	2 305.58	CDMF20-7FSWSC	2 484.11	7.5	CDLF, CDL 20-7
CDM20-8FSWPC	2 638.88	CDMF20-8FSWSC	2 806.33	11	CDLF, CDL 20-8
CDM20-9FSWPC	2 697.84	CDMF20-9FSWSC	2 866.12	11	CDLF, CDL 20-9
CDM20-10FSWPC	2 746.96	CDMF20-10FSWSC	2 925.07	11	CDLF, CDL 20-10
CDM20-11FSWPC	3 117.10	CDMF20-11FSWSC	3 285.38	15	CDLF, CDL 20-11
CDM20-12FSWPC	3 204.31	CDMF20-12FSWSC	3 381.62	15	CDLF, CDL 20-12
CDM20-13FSWPC	3 396.36	CDMF20-13FSWSC	3 564.64	15	CDLF, CDL 20-13
CDM20-14FSWPC	3 570.36	CDMF20-14FSWSC	3 747.67	15	CDLF, CDL 20-14
CDM20-15FSWPC	3 802.13	CDMF20-15FSWSC	3 987.58	18.5	CDLF, CDL 20-15
CDM20-16FSWPC	3 901.62	CDMF20-16FSWSC	4 072.74	18.5	CDLF, CDL 20-16
CDM20-17FSWPC	3 948.70	CDMF20-17FSWSC	4 121.48	18.5	CDLF, CDL 20-17
CDMF, CDM32					
CDM32-1-1FSWPC	1 381.89	CDMF32-1-1FSWSC	1 642.71	1.5	CDLF, CDL 32-10-1
CDM32-1FSWPC	1 413.40	CDMF32-1FSWSC	1 674.21	2.2	CDLF, CDL 32-10
CDM32-2-2FSWPC	1 562.43	CDMF32-2-2FSWSC	1 864.61	3	CDLF, CDL 32-20-2
CDM32-2FSWPC	1 772.08	CDMF32-2FSWSC	2 015.69	4	CDLF, CDL 32-20
CDM32-3-2FSWPC	2 250.33	CDMF32-3-2FSWSC	2 489.85	5.5	CDLF, CDL 32-30-2
CDM32-3FSWPC	2 250.33	CDMF32-3FSWSC	2 489.85	5.5	CDLF, CDL 32-30
CDM32-4-2FSWPC	2 426.36	CDMF32-4-2FSWSC	2 666.30	7.5	CDLF, CDL 32-40-2
CDM32-4FSWPC	2 426.36	CDMF32-4FSWSC	2 666.30	7.5	CDLF, CDL 32-40
CDM32-5-2FSWPC	2 970.11	CDMF32-5-2FSWSC	3 209.22	11	CDLF, CDL 32-50-2
CDM32-5FSWPC	2 970.11	CDMF32-5FSWSC	3 209.22	11	CDLF, CDL 32-50
CDM32-6-2FSWPC	2 988.95	CDMF32-6-2FSWSC	3 217.42	11	CDLF, CDL 32-60-2
CDM32-6FSWPC	2 988.95	CDMF32-6FSWSC	3 217.42	11	CDLF, CDL 32-60
CDM32-7-2FSWPC	3 430.33	CDMF32-7-2FSWSC	3 669.85	15	CDLF, CDL 32-70-2
CDM32-7FSWPC	3 430.33	CDMF32-7FSWSC	3 669.85	15	CDLF, CDL 32-70
CDM32-8-2FSWPC	3 582.23	CDMF32-8-2FSWSC	3 822.59	15	CDLF, CDL 32-80-2
CDM32-8FSWPC	3 582.23	CDMF32-8FSWSC	3 822.59	15	CDLF, CDL 32-80
CDM32-9-2FSWPC	4 081.77	CDMF32-9-2FSWSC	4 322.51	18.5	CDLF, CDL 32-90-2
CDM32-9FSWPC	4 081.77	CDMF32-9FSWSC	4 322.51	18.5	CDLF, CDL 32-90
CDM32-10-2FSWPC	4 261.51	CDMF32-10-2FSWSC	4 501.45	18.5	CDLF, CDL 32-100-2
CDM32-10FSWPC	4 261.51	CDMF32-10FSWSC	4 501.45	18.5	CDLF, CDL 32-100
CDM32-11-2FSWPC	4 906.38	CDMF32-11-2FSWSC	5 124.62	22	CDLF, CDL 32-110-2
CDM32-11FSWPC	4 906.38	CDMF32-11FSWSC	5 124.62	22	CDLF, CDL 32-110
CDM32-12-2FSWPC	5 120.12	CDMF32-12-2FSWSC	5 358.81	22	CDLF, CDL 32-120-2

CDM32-12FSWPC	5 120.12	CDMF32-12FSWSC	5 358.81	22	CDLF, CDL 32-120
CDM32-13-2FSWPC	5 826.82	CDMF32-13-2FSWSC	6 072.08	30	CDLF, CDL 32-130-2
CDM32-13FSWPC	5 826.82	CDMF32-13FSWSC	6 072.08	30	CDLF, CDL 32-130
CDM32-14-2FSWPC	6 061.42	CDMF32-14-2FSWSC	6 284.57	30	CDLF, CDL 32-140-2
CDM32-14FSWPC	6 061.42	CDMF32-14FSWSC	6 284.57	30	CDLF, CDL 32-140
CDM32-15-2FSWPC	6 340.27	CDMF32-15-2FSWSC	6 563.42	30	CDLF, CDL 32-150-2
CDM32-15FSWPC	6 340.27	CDMF32-15FSWSC	6 563.42	30	CDLF, CDL 32-150
CDM32-16-2FSWPC	6 455.73	CDMF32-16-2FSWSC	6 678.87	30	CDLF, CDL 32-160-2
CDM32-16FSWPC	6 455.73	CDMF32-16FSWSC	6 678.87	30	CDLF, CDL 32-160
CDMF, CDM42					
CDM42-1-1FSWPC	1 389.65	CDMF42-1-1FSWSC	2 054.60	3	CDLF, CDL 42-10-1
CDM42-1FSWPC	1 638.21	CDMF42-1FSWSC	2 235.17	4	CDLF, CDL 42-10
CDM42-2-2FSWPC	2 233.92	CDMF42-2-2FSWSC	2 599.97	5.5	CDLF, CDL 42-20-2
CDM42-2FSWPC	2 588.51	CDMF42-2FSWSC	2 963.57	7.5	CDLF, CDL 42-20
CDM42-3-2FSWPC	3 332.88	CDMF42-3-2FSWSC	3 804.17	11	CDLF, CDL 42-30-2
CDM42-3FSWPC	3 342.71	CDMF42-3FSWSC	3 813.17	11	CDLF, CDL 42-30
CDM42-4-2FSWPC	4 264.80	CDMF42-4-2FSWSC	5 243.77	15	CDLF, CDL 42-40-2
CDM42-4FSWPC	4 274.60	CDMF42-4FSWSC	5 252.77	15	CDLF, CDL 42-40
CDM42-5-2FSWPC	5 367.01	CDMF42-5-2FSWSC	6 079.87	18.5	CDLF, CDL 42-50-2
CDM42-5FSWPC	5 376.84	CDMF42-5FSWSC	6 090.09	18.5	CDLF, CDL 42-50
CDM42-6-2FSWPC	6 201.46	CDMF42-6-2FSWSC	7 078.51	22	CDLF, CDL 42-60-2
CDM42-6FSWPC	6 210.87	CDMF42-6FSWSC	7 087.92	22	CDLF, CDL 42-60
CDM42-7-2FSWPC	6 692.79	CDMF42-7-2FSWSC	7 832.29	30	CDLF, CDL 42-70-2
CDM42-7FSWPC	6 702.62	CDMF42-7FSWSC	7 841.29	30	CDLF, CDL 42-70
CDM42-8-2FSWPC	6 933.97	CDMF42-8-2FSWSC	8 066.07	30	CDLF, CDL 42-80-2
CDM42-8FSWPC	6 943.78	CDMF42-8FSWSC	8 107.85	30	CDLF, CDL 42-80
CDM42-9-2FSWPC	7 176.34	CDMF42-9-2FSWSC	8 240.92	30	CDLF, CDL 42-90-2
CDM42-9FSWPC	8 110.72	CDMF42-9FSWSC	8 749.43	37	CDLF, CDL 42-90
CDM42-10-2FSWPC	8 342.87	CDMF42-10-2FSWSC	9 120.40	37	CDLF, CDL 42-100-2
CDM42-10FSWPC	8 351.87	CDMF42-10FSWSC	9 129.40	37	CDLF, CDL 42-100
CDM42-11-2FSWPC	10 883.06	CDMF42-11-2FSWSC	12 033.60	45	CDLF, CDL 42-110-2
CDM42-11FSWPC	10 892.06	CDMF42-11FSWSC	12 043.43	45	CDLF, CDL 42-110
CDM42-12-2FSWPC	11 158.62	CDMF42-12-2FSWSC	12 334.54	45	CDLF, CDL 42-120-2
CDM42-12FSWPC	11 168.04	CDMF42-12FSWSC	12 343.57	45	CDLF, CDL 42-120
CDM42-13-2FSWPC	11 442.77	CDMF42-13-2FSWSC	12 641.22	45	CDLF, CDL 42-130-2
CDMF, CDM65					
CDM65-1-1FSWPC	1 615.67	CDMF65-1-1FSWSC	2 456.69	4	CDLF, CDL 65-10-1
CDM65-1FSWPC	2 127.88	CDMF65-1FSWSC	2 591.39	5.5	CDLF, CDL 65-10
CDM65-2-2FSWPC	2 520.97	CDMF65-2-2FSWSC	2 973.40	7.5	CDLF, CDL 65-20-2
CDM65-2-1FSWPC	3 467.19	CDMF65-2-1FSWSC	3 732.51	11	CDLF, CDL 65-20-1
CDM65-2FSWPC	3 472.50	CDMF65-2FSWSC	3 737.43	11	CDLF, CDL 65-20
CDM65-3-2FSWPC	4 399.50	CDMF65-3-2FSWSC	5 039.04	15	CDLF, CDL 65-30-2
CDM65-3-1FSWPC	4 408.50	CDMF65-3-1FSWSC	5 048.46	15	CDLF, CDL 65-30-1
CDM65-3FSWPC	4 969.04	CDMF65-3FSWSC	5 599.58	18.5	CDLF, CDL 65-30
CDM65-4-2FSWPC	5 012.84	CDMF65-4-2FSWSC	5 852.61	18.5	CDLF, CDL 65-40-2
CDM65-4-1FSWPC	5 925.51	CDMF65-4-1FSWSC	6 763.62	22	CDLF, CDL 65-40-1
CDM65-4FSWPC	5 931.22	CDMF65-4FSWSC	6 767.32	22	CDLF, CDL 65-40
CDM65-5-2FSWPC	6 352.56	CDMF65-5-2FSWSC	7 222.21	30	CDLF, CDL 65-50-2
CDM65-5-1FSWPC	6 357.06	CDMF65-5-1FSWSC	7 226.71	30	CDLF, CDL 65-50-1
CDM65-5FSWPC	6 361.56	CDMF65-5FSWSC	7 231.21	30	CDLF, CDL 65-50
CDM65-6-2FSWPC	6 618.68	CDMF65-6-2FSWSC	7 486.31	30	CDLF, CDL 65-60-2
CDM65-6-1FSWPC	7 773.75	CDMF65-6-1FSWSC	8 132.01	37	CDLF, CDL 65-60-1
CDM65-6FSWPC	7 777.83	CDMF65-6FSWSC	8 136.93	37	CDLF, CDL 65-60
CDM65-7-2FSWPC	7 900.24	CDMF65-7-2FSWSC	8 397.33	37	CDLF, CDL 65-70-2
CDM65-7-1FSWPC	7 905.57	CDMF65-7-1FSWSC	8 402.24	37	CDLF, CDL 65-70-1
CDM65-7FSWPC	9 681.35	CDMF65-7FSWSC	10 335.23	45	CDLF, CDL 65-70

CDM65-8-2FSWPC	10 965.38	CDMF65-8-2FSWSC	11 584.84	45	CDLF, CDL 65-80-2
CDM65-8-1FSWPC	10 975.18	CDMF65-8-1FSWSC	11 590.17	45	CDLF, CDL 65-80-1
CDMF, CDM85					
CDM85-1-1FSWPC	2 887.82	CDMF85-1-1FSWSC	3 705.48	5.5	CDLF, CDL 85-10-1
CDM85-1FSWPC	3 134.31	CDMF85-1FSWSC	3 950.74	7.5	CDLF, CDL 85-10
CDM85-2-2FSWPC	3 472.50	CDMF85-2-2FSWSC	4 379.01	11	CDLF, CDL 85-20-2
CDM85-2FSWPC	4 508.82	CDMF85-2FSWSC	5 344.09	15	CDLF, CDL 85-20
CDM85-3-2FSWPC	5 235.98	CDMF85-3-2FSWSC	6 221.53	18.5	CDLF, CDL 85-30-2
CDM85-3FSWPC	5 749.86	CDMF85-3FSWSC	6 747.66	22	CDLF, CDL 85-30
CDM85-4-2FSWPC	6 473.76	CDMF85-4-2FSWSC	7 495.31	30	CDLF, CDL 85-40-2
CDM85-4FSWPC	6 483.56	CDMF85-4FSWSC	7 505.14	30	CDLF, CDL 85-40
CDM85-5-2FSWPC	7 783.16	CDMF85-5-2FSWSC	8 166.80	37	CDLF, CDL 85-50-2
CDM85-5FSWPC	7 793.38	CDMF85-5FSWSC	8 176.22	37	CDLF, CDL 85-50
CDM85-6-2FSWPC	9 915.96	CDMF85-6-2FSWSC	10 593.17	45	CDLF, CDL 85-60-2
CDM85-6FSWPC	9 925.38	CDMF85-6FSWSC	10 602.20	45	CDLF, CDL 85-60

CDL вертикальные многоступенчатые насосы

CDL F 2 - 2 2A - B	F: модель из нерж. стали	Количество ступеней	2A - B: 2 уменьшенных рабочих колеса тип А	F1: исполнение фланец на резьбе	S: стандартное исполнение (прайс) 3ф. До 3 кВт для 220/380В От 3 кВт для 380В	Частота	W: 50Гц (прайс)	
	Номинальная подача, м³/ч	1 уменьшенное рабочих колеса тип В	Y: исполнение с овальным фланцем	D: 1ф. 220В	Проточная часть	L: 60Гц		
	CDL – Вертикальный многоступенчатый центробежный насос Материалы насосов: Диффузор, рабочее колесо всех типов насосов из нерж. стали 304/316L; Насосы CDL - головная и проточная части из чугуна HT200; Насосы CDLF - головная и проточная части из нерж. стали 304/316L; Уплотнение - резина NBR/керамика			K: режущая муфта, совместное подключение	B: только насосная часть	S: нерж.сталь SS304 (прайс)		
	Насосы с двигателем мощностью ниже 7,5 кВт поставляются с двигателем В14.			L: резьбовое соединение труб	Q: 3-х фазное, 1500об/мин	L: нерж.сталь SS316 (+ 30%, к цене насоса из нерж. ст. SS304.)		
	Цена насосов с электродвигателем IE3 рассчитывается как цена стандарт.насоса +5%			R: высоко-температурное исполнение (+5 град.С...+120 град.С) (+ 5% к цене стд. насоса)				
	Цена насосов: CDLF, CDL1-85T из нерж. стали SS316, + 30% к цене насоса из нерж. ст. SS304, CDLF, CDL120-200T из SS316, цена + 25%, к цене насоса из нерж. ст. SS304;							

обновление
25.04.2022

Входная, выходная камеры - чугун CI		Входная, выходная камеры -нерж. SS304		Мощность (кВт)
Модель/арт. CDL	Цена розница (USD) с НДС	Модель/арт. CDLF	Цена розница (USD) с НДС	
CDLF, CDL 1				
CDL1-2FSWPC	377.34	CDLF1-2FSWSC	468.81	0.37
CDL1-3FSWPC	410.37	CDLF1-3FSWSC	500.58	0.37
CDL1-4FSWPC	435.78	CDLF1-4FSWSC	527.26	0.37
CDL1-5FSWPC	482.79	CDLF1-5FSWSC	574.27	0.37
CDL1-6FSWPC	541.23	CDLF1-6FSWSC	632.71	0.37
CDL1-7FSWPC	578.08	CDLF1-7FSWSC	669.55	0.37
CDL1-8FSWPC	620.00	CDLF1-8FSWSC	711.48	0.55
CDL1-9FSWPC	640.33	CDLF1-9FSWSC	731.81	0.55
CDL1-10FSWPC	672.09	CDLF1-10FSWSC	763.57	0.55
CDL1-11FSWPC	689.88	CDLF1-11FSWSC	781.36	0.55
CDL1-12FSWPC	750.87	CDLF1-12FSWSC	842.34	0.75
CDL1-13FSWPC	767.38	CDLF1-13FSWSC	858.86	0.75
CDL1-14FSWPC	792.79	CDLF1-14FSWSC	884.27	0.75
CDL1-15FSWPC	809.31	CDLF1-15FSWSC	900.78	0.75
CDL1-16FSWPC	818.20	CDLF1-16FSWSC	908.41	1.1
CDL1-17FSWPC	824.55	CDLF1-17FSWSC	916.03	1.1
CDL1-18FSWPC	860.13	CDLF1-18FSWSC	950.33	1.1
CDL1-19FSWPC	893.16	CDLF1-19FSWSC	984.64	1.1
CDL1-20FSWPC	914.76	CDLF1-20FSWSC	1 004.97	1.1
CDL1-21FSWPC	947.79	CDLF1-21FSWSC	1 039.27	1.1/1.4
CDL1-22FSWPC	1 008.78	CDLF1-22FSWSC	1 100.25	1.1/1.4
CDL1-23FSWPC	1 016.40	CDLF1-23FSWSC	1 106.61	1.1/1.4

CDL1-24FSWPC	1 069.76	CDLF1-24FSWSC	1 159.97	1.5
CDL1-25FSWPC	1 078.65	CDLF1-25FSWSC	1 170.13	1.5
CDL1-26FSWPC	1 096.44	CDLF1-26FSWSC	1 187.92	1.5
CDL1-27FSWPC	1 128.20	CDLF1-27FSWSC	1 218.41	1.5/1.8
CDL1-28FSWPC	1 135.83	CDLF1-28FSWSC	1 227.30	1.5/1.8
CDL1-29FSWPC	1 144.72	CDLF1-29FSWSC	1 236.20	1.5/1.8
CDL1-30FSWPC	1 153.61	CDLF1-30FSWSC	1 245.09	1.5/1.8
CDL1-31FSWPC	1 251.44	CDLF1-31FSWSC	1 342.92	2.2
CDL1-32FSWPC	1 364.52	CDLF1-32FSWSC	1 454.72	2.2
CDL1-33FSWPC	1 475.05	CDLF1-33FSWSC	1 566.53	2.2
CDL1-34FSWPC	1 503.00	CDLF1-34FSWSC	1 594.48	2.2
CDL1-35FSWPC	1 530.95	CDLF1-35FSWSC	1 622.43	2.2
CDL1-36FSWPC	1 558.90	CDLF1-36FSWSC	1 649.11	2.2
CDLF,CDL 2				
CDL2-2FSWPC	364.63	CDLF2-2FSWSC	456.11	0.37
CDL2-3FSWPC	414.18	CDLF2-3FSWSC	504.39	0.37
CDL2-4FSWPC	484.06	CDLF2-4FSWSC	575.54	0.55
CDL2-5FSWPC	512.01	CDLF2-5FSWSC	603.49	0.55
CDL2-6FSWPC	581.89	CDLF2-6FSWSC	673.37	0.75
CDL2-7FSWPC	609.84	CDLF2-7FSWSC	701.32	0.75
CDL2-8FSWPC	631.44	CDLF2-8FSWSC	722.91	1.1
CDL2-9FSWPC	651.77	CDLF2-9FSWSC	743.24	1.1
CDL2-10FSWPC	705.13	CDLF2-10FSWSC	795.33	1.1
CDL2-11FSWPC	724.19	CDLF2-11FSWSC	814.39	1.1/1.4
CDL2-12FSWPC	781.36	CDLF2-12FSWSC	871.56	1.5
CDL2-13FSWPC	792.79	CDLF2-13FSWSC	884.27	1.5
CDL2-14FSWPC	814.39	CDLF2-14FSWSC	905.87	1.5
CDL2-15FSWPC	848.69	CDLF2-15FSWSC	940.17	1.5/1.8
CDL2-16FSWPC	872.83	CDLF2-16FSWSC	964.31	2.2
CDL2-17FSWPC	898.24	CDLF2-17FSWSC	988.45	2.2
CDL2-18FSWPC	905.87	CDLF2-18FSWSC	997.34	2.2
CDL2-19FSWPC	940.17	CDLF2-19FSWSC	1 031.65	2.2
CDL2-20FSWPC	968.12	CDLF2-20FSWSC	1 059.60	2.2
CDL2-21FSWPC	992.26	CDLF2-21FSWSC	1 082.47	2.2
CDL2-22FSWPC	1 013.86	CDLF2-22FSWSC	1 104.06	2.2/2.6
CDL2-23FSWPC	1 096.44	CDLF2-23FSWSC	1 187.92	3
CDL2-24FSWPC	1 119.31	CDLF2-24FSWSC	1 210.79	3
CDL2-25FSWPC	1 129.47	CDLF2-25FSWSC	1 219.68	3
CDL2-26FSWPC	1 138.37	CDLF2-26FSWSC	1 229.84	3
CDLF,CDL 3				
CDL3-2FSWPC	398.94	CDLF3-2FSWSC	490.41	0.37
CDL3-3FSWPC	435.78	CDLF3-3FSWSC	527.26	0.37
CDL3-4FSWPC	477.71	CDLF3-4FSWSC	569.18	0.37
CDL3-5FSWPC	514.55	CDLF3-5FSWSC	606.03	0.37
CDL3-6FSWPC	584.43	CDLF3-6FSWSC	673.37	0.55
CDL3-7FSWPC	604.76	CDLF3-7FSWSC	694.96	0.55
CDL3-8FSWPC	672.09	CDLF3-8FSWSC	763.57	0.75
CDL3-9FSWPC	698.78	CDLF3-9FSWSC	790.25	0.75
CDL3-10FSWPC	741.97	CDLF3-10FSWSC	830.91	0.75
CDL3-11FSWPC	778.82	CDLF3-11FSWSC	869.02	1.1
CDL3-12FSWPC	804.23	CDLF3-12FSWSC	895.70	1.1

CDL3-13FSWPC	829.64	CDLF3-13FSWSC	921.11	1.1
CDL3-14FSWPC	860.13	CDLF3-14FSWSC	950.33	1.1
CDL3-15FSWPC	903.33	CDLF3-15FSWSC	994.80	1.1/1.4
CDL3-16FSWPC	963.04	CDLF3-16FSWSC	1 054.52	1.5
CDL3-17FSWPC	979.56	CDLF3-17FSWSC	1 071.03	1.5
CDL3-18FSWPC	1 006.24	CDLF3-18FSWSC	1 097.71	1.5
CDL3-19FSWPC	1 048.16	CDLF3-19FSWSC	1 139.64	1.5/1.8
CDL3-20FSWPC	1 086.28	CDLF3-20FSWSC	1 177.75	2.2
CDL3-21FSWPC	1 109.15	CDLF3-21FSWSC	1 199.35	2.2
CDL3-22FSWPC	1 140.91	CDLF3-22FSWSC	1 232.39	2.2
CDL3-23FSWPC	1 173.94	CDLF3-23FSWSC	1 265.42	2.2
CDL3-24FSWPC	1 206.98	CDLF3-24FSWSC	1 297.18	2.2
CDL3-25FSWPC	1 238.74	CDLF3-25FSWSC	1 330.21	2.2
CDL3-26FSWPC	1 278.12	CDLF3-26FSWSC	1 369.60	2.2
CDL3-27FSWPC	1 337.84	CDLF3-27FSWSC	1 429.31	2.2/2.6
CDL3-28FSWPC	1 410.26	CDLF3-28FSWSC	1 501.73	2.2/2.6
CDL3-29FSWPC	1 481.40	CDLF3-29FSWSC	1 571.61	2.2/2.6
CDL3-30FSWPC	1 577.96	CDLF3-30FSWSC	1 668.17	3
CDL3-31FSWPC	1 598.29	CDLF3-31FSWSC	1 688.49	3
CDL3-32FSWPC	1 642.76	CDLF3-32FSWSC	1 734.23	3
CDL3-33FSWPC	1 687.22	CDLF3-33FSWSC	1 778.70	3
CDL3-34FSWPC	1 735.50	CDLF3-34FSWSC	1 826.98	3
CDL3-35FSWPC	1 782.51	CDLF3-35FSWSC	1 873.99	3
CDL3-36FSWPC	1 830.79	CDLF3-36FSWSC	1 921.00	3
CDLF,CDL 4				
CDL4-2FSWPC	410.37	CDLF4-2FSWSC	500.58	0.37
CDL4-3FSWPC	435.78	CDLF4-3FSWSC	527.26	0.55
CDL4-4FSWPC	517.09	CDLF4-4FSWSC	607.30	0.75
CDL4-5FSWPC	581.89	CDLF4-5FSWSC	673.37	1.1
CDL4-6FSWPC	621.27	CDLF4-6FSWSC	712.75	1.1
CDL4-7FSWPC	712.75	CDLF4-7FSWSC	804.23	1.5
CDL4-8FSWPC	725.46	CDLF4-8FSWSC	815.66	1.5
CDL4-9FSWPC	781.36	CDLF4-9FSWSC	871.56	2.2
CDL4-10FSWPC	800.42	CDLF4-10FSWSC	890.62	2.2
CDL4-11FSWPC	819.47	CDLF4-11FSWSC	909.68	2.2
CDL4-12FSWPC	858.86	CDLF4-12FSWSC	949.06	2.2/2.6
CDL4-13FSWPC	977.01	CDLF4-13FSWSC	1 067.22	3
CDL4-14FSWPC	983.37	CDLF4-14FSWSC	1 074.84	3
CDL4-15FSWPC	1 015.13	CDLF4-15FSWSC	1 105.34	3
CDL4-16FSWPC	1 043.08	CDLF4-16FSWSC	1 134.56	3
CDL4-17FSWPC	1 195.54	CDLF4-17FSWSC	1 287.02	4
CDL4-18FSWPC	1 246.36	CDLF4-18FSWSC	1 336.57	4
CDL4-19FSWPC	1 332.75	CDLF4-19FSWSC	1 424.23	4
CDL4-20FSWPC	1 396.28	CDLF4-20FSWSC	1 487.76	4
CDL4-21FSWPC	1 443.29	CDLF4-21FSWSC	1 533.49	4
CDL4-22FSWPC	1 551.28	CDLF4-22FSWSC	1 642.76	4/4.5
CDLF,CDL 8				
CDL8-2/1FSWPC	595.86	CDLF8-2/1FSWSC	750.87	0.75
CDL8-2FSWPC	618.73	CDLF8-2FSWSC	773.73	0.75
CDL8-3FSWPC	682.26	CDLF8-3FSWSC	834.72	1.1
CDL8-4FSWPC	748.32	CDLF8-4FSWSC	903.33	1.5

CDL8-5FSWPC	828.37	CDLF8-5FSWSC	983.37	2.2
CDL8-6FSWPC	891.89	CDLF8-6FSWSC	1 046.89	2.2
CDL8-7FSWPC	1 060.87	CDLF8-7FSWSC	1 215.87	3
CDL8-8FSWPC	1 176.48	CDLF8-8FSWSC	1 331.48	3
CDL8-9FSWPC	1 345.46	CDLF8-9FSWSC	1 500.46	4
CDL8-10FSWPC	1 542.39	CDLF8-10FSWSC	1 697.39	4
CDL8-11FSWPC	1 674.52	CDLF8-11FSWSC	1 829.52	4
CDL8-12FSWPC	1 749.48	CDLF8-12FSWSC	1 903.21	4/4,5
CDL8-13FSWPC	1 951.49	CDLF8-13FSWSC	2 106.49	5.5
CDL8-14FSWPC	2 039.15	CDLF8-14FSWSC	2 194.15	5.5
CDL8-15FSWPC	2 072.19	CDLF8-15FSWSC	2 227.19	5.5
CDL8-16FSWPC	2 147.15	CDLF8-16FSWSC	2 302.15	5,5/6
CDL8-17FSWPC	2 281.82	CDLF8-17FSWSC	2 435.55	7.5
CDL8-18FSWPC	2 341.53	CDLF8-18FSWSC	2 496.53	7.5
CDL8-19FSWPC	2 407.60	CDLF8-19FSWSC	2 562.60	7.5
CDL8-20FSWPC	2 464.77	CDLF8-20FSWSC	2 619.77	7.5
CDLF,CDL 10				
CDL10-1FSWPC	898.24	CDLF10-1FSWSC	1 161.24	0.75
CDL10-2FSWPC	910.95	CDLF10-2FSWSC	1 171.40	0.75
CDL10-3FSWPC	965.58	CDLF10-3FSWSC	1 229.84	1.1
CDL10-4FSWPC	1 104.06	CDLF10-4FSWSC	1 361.98	1.5
CDL10-5FSWPC	1 223.49	CDLF10-5FSWSC	1 486.49	2.2
CDL10-6FSWPC	1 267.96	CDLF10-6FSWSC	1 530.95	2.2
CDL10-7FSWPC	1 565.26	CDLF10-7FSWSC	1 839.68	3
CDL10-8FSWPC	1 610.99	CDLF10-8FSWSC	1 887.96	3
CDL10-9FSWPC	1 717.72	CDLF10-9FSWSC	1 992.14	3
CDL10-10FSWPC	1 942.59	CDLF10-10FSWSC	2 217.02	4
CDL10-11FSWPC	1 995.96	CDLF10-11FSWSC	2 269.11	4
CDL10-12FSWPC	2 044.23	CDLF10-12FSWSC	2 316.12	4
CDL10-13FSWPC	3 026.33	CDLF10-13FSWSC	3 359.20	5.5
CDL10-14FSWPC	3 082.23	CDLF10-14FSWSC	3 415.10	5.5
CDL10-15FSWPC	3 172.44	CDLF10-15FSWSC	3 505.31	5.5
CDL10-16FSWPC	3 288.05	CDLF10-16FSWSC	3 620.93	5.5
CDL10-17FSWPC	3 382.07	CDLF10-17FSWSC	3 714.94	7.5
CDL10-18FSWPC	3 436.70	CDLF10-18FSWSC	3 770.84	7.5
CDL10-19FSWPC	3 493.88	CDLF10-19FSWSC	3 825.48	7.5
CDL10-20FSWPC	3 549.78	CDLF10-20FSWSC	3 883.92	7.5
CDL10-21FSWPC	3 702.24	CDLF10-21FSWSC	4 008.43	7.5
CDL10-22FSWPC	3 732.73	CDLF10-22FSWSC	4 065.60	7.5
CDLF,CDL 12				
CDL12-2FSWPC	783.90	CDLF12-2FSWSC	954.15	1.5
CDL12-3FSWPC	871.56	CDLF12-3FSWSC	1 043.08	2.2
CDL12-4FSWPC	1 020.21	CDLF12-4FSWSC	1 190.46	3
CDL12-5FSWPC	1 035.46	CDLF12-5FSWSC	1 205.70	3
CDL12-6FSWPC	1 218.41	CDLF12-6FSWSC	1 389.93	4
CDL12-7FSWPC	1 557.63	CDLF12-7FSWSC	1 726.61	5.5
CDL12-8FSWPC	1 595.75	CDLF12-8FSWSC	1 766.00	5.5
CDL12-9FSWPC	1 697.39	CDLF12-9FSWSC	1 868.91	5.5
CDL12-10FSWPC	1 959.11	CDLF12-10FSWSC	2 130.63	7.5
CDL12-11FSWPC	2 032.80	CDLF12-11FSWSC	2 203.05	7.5
CDL12-12FSWPC	2 054.40	CDLF12-12FSWSC	2 225.92	7.5

CDL12-13FSWPC	2 410.14	CDLF12-13FSWSC	2 579.12	11
CDL12-14FSWPC	2 483.83	CDLF12-14FSWSC	2 654.07	11
CDL12-15FSWPC	2 557.52	CDLF12-15FSWSC	2 729.03	11
CDL12-16FSWPC	2 651.53	CDLF12-16FSWSC	2 821.78	11
CDL12-17FSWPC	2 713.79	CDLF12-17FSWSC	2 884.04	11
CDL12-18FSWPC	2 776.04	CDLF12-18FSWSC	2 947.56	11
CDLF,CDL 15				
CDL15-1FSWPC	826.49	CDLF15-1FSWSC	1 032.28	1.1
CDL15-2FSWPC	918.53	CDLF15-2FSWSC	1 074.77	2.2
CDL15-3FSWPC	1 142.89	CDLF15-3FSWSC	1 299.13	3
CDL15-4FSWPC	1 317.67	CDLF15-4FSWSC	1 473.94	4
CDL15-5FSWPC	1 437.30	CDLF15-5FSWSC	1 593.57	4
CDL15-6FSWPC	1 730.37	CDLF15-6FSWSC	1 886.12	5.5
CDL15-7FSWPC	1 748.83	CDLF15-7FSWSC	1 904.59	5.5
CDL15-8FSWPC	1 953.72	CDLF15-8FSWSC	2 111.50	7.5
CDL15-9FSWPC	2 069.82	CDLF15-9FSWSC	2 253.89	7.5
CDL15-10FSWPC	2 393.87	CDLF15-10FSWSC	2 627.68	11
CDL15-11FSWPC	2 629.84	CDLF15-11FSWSC	2 786.09	11
CDL15-12FSWPC	2 724.99	CDLF15-12FSWSC	2 881.24	11
CDL15-13FSWPC	2 821.61	CDLF15-13FSWSC	2 977.86	11
CDL15-14FSWPC	2 918.23	CDLF15-14FSWSC	3 074.47	11
CDL15-15FSWPC	3 153.71	CDLF15-15FSWSC	3 309.96	15
CDL15-16FSWPC	3 272.40	CDLF15-16FSWSC	3 428.64	15
CDL15-17FSWPC	3 337.48	CDLF15-17FSWSC	3 473.82	15
CDLF,CDL 20				
CDL20-1FSWPC	1 025.29	CDLF20-1FSWSC	1 182.84	1.1
CDL20-2FSWPC	1 182.84	CDLF20-2FSWSC	1 392.47	2.2
CDL20-3FSWPC	1 567.80	CDLF20-3FSWSC	1 752.02	4
CDL20-4FSWPC	1 852.39	CDLF20-4FSWSC	2 036.61	5.5
CDL20-5FSWPC	1 968.00	CDLF20-5FSWSC	2 150.96	5.5
CDL20-6FSWPC	2 234.81	CDLF20-6FSWSC	2 419.03	7.5
CDL20-7FSWPC	2 295.79	CDLF20-7FSWSC	2 478.75	7.5
CDL20-8FSWPC	2 617.23	CDLF20-8FSWSC	2 790.02	11
CDL20-9FSWPC	2 673.13	CDLF20-9FSWSC	2 851.00	11
CDL20-10FSWPC	2 729.03	CDLF20-10FSWSC	2 911.99	11
CDL20-11FSWPC	3 014.90	CDLF20-11FSWSC	3 197.85	15
CDL20-12FSWPC	3 183.87	CDLF20-12FSWSC	3 368.10	15
CDL20-13FSWPC	3 373.18	CDLF20-13FSWSC	3 557.40	15
CDL20-14FSWPC	3 562.48	CDLF20-14FSWSC	3 746.70	15
CDL20-15FSWPC	3 741.62	CDLF20-15FSWSC	3 924.57	18.5
CDL20-16FSWPC	3 821.66	CDLF20-16FSWSC	4 002.08	18.5
CDL20-17FSWPC	3 901.71	CDLF20-17FSWSC	4 080.85	18.5
CDLF,CDL 32				
CDL32-10-1FSWPC	1 402.63	CDLF32-10-1FSWSC	1 671.98	1.5
CDL32-10FSWPC	1 433.12	CDLF32-10FSWSC	1 702.47	2.2
CDL32-20-2FSWPC	1 636.40	CDLF32-20-2FSWSC	1 948.95	3
CDL32-20FSWPC	1 743.13	CDLF32-20FSWSC	2 205.59	4
CDL32-30FSWPC	2 227.19	CDLF32-30FSWSC	2 575.30	5.5
CDL32-40FSWPC	2 406.33	CDLF32-40FSWSC	2 754.44	7.5
CDL32-50FSWPC	2 859.90	CDLF32-50FSWSC	3 106.37	11

CDL32-60FSWPC	2 993.30	CDLF32-60FSWSC	3 214.37	11
CDL32-70FSWPC	3 417.65	CDLF32-70FSWSC	3 666.66	15
CDL32-80FSWPC	3 576.46	CDLF32-80FSWSC	3 822.93	15
CDL32-90FSWPC	4 038.92	CDLF32-90FSWSC	4 287.94	18.5
CDL32-100FSWPC	4 225.68	CDLF32-100FSWSC	4 474.70	18.5
CDL32-110FSWPC	4 885.07	CDLF32-110FSWSC	5 106.14	22
CDL32-120FSWPC	5 101.06	CDLF32-120FSWSC	5 348.81	22
CDL32-130FSWPC	6 219.10	CDLF32-130FSWSC	6 856.89	30
CDL32-140FSWPC	6 395.70	CDLF32-140FSWSC	7 076.69	30
CDL32-150-2FSWPC	6 724.76	CDLF32-150-2FSWSC	7 405.74	30
CDL32-150FSWPC	6 724.76	CDLF32-150FSWSC	7 405.74	30
CDL32-160-2FSWPC	6 860.70	CDLF32-160-2FSWSC	7 541.69	30
CDL32-160FSWPC	6 860.70	CDLF32-160FSWSC	7 541.69	30
CDLF,CDL 42				
CDL42-10-1FSWPC	1 548.74	CDLF42-10-1FSWSC	2 167.47	3
CDL42-10FSWPC	1 654.19	CDLF42-10FSWSC	2 271.65	4
CDL42-20-2FSWPC	2 558.79	CDLF42-20-2FSWSC	2 946.29	5.5
CDL42-20 FSWPC	2 588.01	CDLF42-20 FSWSC	2 975.51	7.5
CDL42-30-2FSWPC	3 345.23	CDLF42-30-2FSWSC	3 833.10	11
CDL42 -30FSWPC	3 345.23	CDLF42 -30FSWSC	3 833.10	11
CDL42-40-2FSWPC	4 291.75	CDLF42-40-2FSWSC	5 304.34	15
CDL42-40FSWPC	4 291.75	CDLF42-40FSWSC	5 304.34	15
CDL42-50-2FSWPC	4 718.64	CDLF42-50-2FSWSC	6 117.46	18.5
CDL42-50FSWPC	4 718.64	CDLF42-50FSWSC	6 117.46	18.5
CDL42-60-2FSWPC	5 328.48	CDLF42-60-2FSWSC	6 779.39	22
CDL42-60 FSWPC	5 328.48	CDLF42-60 FSWSC	6 779.39	22
CDL42-70-2FSWPC	6 645.99	CDLF42-70-2FSWSC	7 823.74	30
CDL42-70FSWPC	6 645.99	CDLF42-70FSWSC	7 823.74	30
CDL42-80-2FSWPC	6 896.27	CDLF42-80-2FSWSC	8 100.71	30
CDL42-80 FSWPC	6 896.27	CDLF42-80 FSWSC	8 100.71	30
CDL42-90-2FSWPC	7 767.84	CDLF42-90-2FSWSC	8 490.75	30
CDL42-90 FSWPC	8 009.23	CDLF42-90 FSWSC	8 730.88	37
CDL42-100-2FSWPC	8 319.23	CDLF42-100-2FSWSC	9 124.73	37
CDL42-100 FSWPC	8 319.23	CDLF42-100 FSWSC	9 124.73	37
CDL42-110-2FSWPC	10 853.88	CDLF42-110-2FSWSC	12 046.88	45
CDL42-110 FSWPC	10 853.88	CDLF42-110 FSWSC	12 046.88	45
CDL42-120-2FSWPC	11 139.74	CDLF42-120-2FSWSC	12 356.88	45
CDL42-120 FSWPC	11 139.74	CDLF42-120 FSWSC	12 356.88	45
CDL42-130-2FSWPC	11 425.61	CDLF42-130-2FSWSC	12 665.61	45
CDLF,CDL 65				
CDL65-10-1FSWPC	1 820.63	CDLF65-10-1FSWSC	2 500.34	4
CDL65-10FSWPC	2 060.75	CDLF65-10FSWSC	2 734.12	5.5
CDL65-20-2FSWPC	3 106.37	CDLF65-20-2FSWSC	3 431.62	7.5
CDL65-20-1FSWPC	3 464.65	CDLF65-20-1FSWSC	3 742.89	11
CDL65-20FSWPC	3 479.90	CDLF65-20FSWSC	3 754.33	11
CDL65-30-2FSWPC	4 049.08	CDLF65-30-2FSWSC	4 987.98	15
CDL65-30-1FSWPC	4 064.33	CDLF65-30-1FSWSC	5 000.69	15
CDL65-30FSWPC	4 158.35	CDLF65-30FSWSC	5 093.43	18.5
CDL65-40-2FSWPC	4 497.57	CDLF65-40-2FSWSC	5 394.54	18.5
CDL65-40-1FSWPC	4 830.44	CDLF65-40-1FSWSC	5 724.87	22
CDL65-40FSWPC	4 845.69	CDLF65-40FSWSC	5 738.85	22

CDL65-50-2FSWPC	6 283.89	CDLF65-50-2FSWSC	7 183.41	30
CDL65-50-1FSWPC	6 287.70	CDLF65-50-1FSWSC	7 188.49	30
CDL65-50FSWPC	6 294.06	CDLF65-50FSWSC	7 193.57	30
CDL65-60-2FSWPC	6 968.69	CDLF65-60-2FSWSC	7 833.90	30
CDL65-60-1FSWPC	7 220.25	CDLF65-60-1FSWSC	8 085.46	37
CDL65-60FSWPC	7 234.23	CDLF65-60FSWSC	8 096.90	37
CDL65-70-2FSWPC	7 851.69	CDLF65-70-2FSWSC	9 380.10	37
CDL65-70-1FSWPC	7 856.77	CDLF65-70-1FSWSC	9 397.89	37
CDL65-70FSWPC	8 748.66	CDLF65-70FSWSC	10 278.35	45
CDL65-80-2FSWPC	10 930.11	CDLF65-80-2FSWSC	11 571.71	45
CDL65-80-1FSWPC	10 940.28	CDLF65-80-1FSWSC	11 578.07	45
CDLF,CDL 85				
CDL85-10-1FSWPC	2 904.36	CDLF85-10-1FSWSC	3 967.77	5.5
CDL85-10FSWPC	2 937.40	CDLF85-10FSWSC	3 996.99	7.5
CDL85-20-2FSWPC	4 426.42	CDLF85-20-2FSWSC	5 290.36	11
CDL85-20FSWPC	4 534.41	CDLF85-20FSWSC	5 398.35	15
CDL85-30-2FSWPC	5 408.52	CDLF85-30-2FSWSC	5 971.35	18.5
CDL85-30FSWPC	5 754.09	CDLF85-30FSWSC	6 305.49	22
CDL85-40-2FSWPC	6 408.40	CDLF85-40-2FSWSC	7 466.73	30
CDL85-40FSWPC	6 418.57	CDLF85-40FSWSC	7 475.62	30
CDL85-50-2FSWPC	7 730.99	CDLF85-50-2FSWSC	8 127.39	37
CDL85-50FSWPC	7 741.16	CDLF85-50FSWSC	8 136.28	37
CDL85-60-2FSWPC	9 843.83	CDLF85-60-2FSWSC	10 543.88	45
CDL85-60FSWPC	9 855.27	CDLF85-60FSWSC	10 555.31	45
CDLF,CDL 120				
CDL120-10FSWPC	по запросу	CDLF120-10FSWSC	по запросу	11
CDL120-20-2FSWPC		CDLF120-20-2FSWSC		15
CDL120-20-1FSWPC		CDLF120-20-1FSWSC		18.5
CDL120-20FSWPC		CDLF120-20FSWSC		22
CDL120-30-2FSWPC		CDLF120-30-2FSWSC		30
CDL120-30-1FSWPC		CDLF120-30-1FSWSC		30
CDL120-30FSWPC		CDLF120-30FSWSC		30
CDL120-40-2FSWPC		CDLF120-40-2FSWSC		37
CDL120-40-1FSWPC		CDLF120-40-1FSWSC		37
CDL120-40FSWPC		CDLF120-40FSWSC		45
CDL120-50-2FSWPC		CDLF120-50-2FSWSC		45
CDL120-50-1FSWPC		CDLF120-50-1FSWSC		45
CDL120-50FSWPC		CDLF120-50FSWSC		55
CDL120-60-2FSWPC		CDLF120-60-2FSWSC		55
CDL120-60-1FSWPC		CDLF120-60-1FSWSC		55
CDL120-60FSWPC		CDLF120-60FSWSC		75
CDL120-70-2FSWPC		CDLF120-70-2FSWSC		75
CDL120-70-1FSWPC	CDLF120-70-1FSWSC	75		
CDL120-70FSWPC	CDLF120-70FSWSC	75		
CDLF,CDL 150				
CDL150-10-1FSWPC	по запросу	CDLF150-10-1FSWSC	по запросу	11
CDL150-10FSWPC		CDLF150-10FSWSC		15
CDL150-20-2FSWPC		CDLF150-20-2FSWSC		18.5
CDL150-20-1FSWPC		CDLF150-20-1FSWSC		22
CDL150-20FSWPC		CDLF150-20FSWSC		30

CDL150-30-2FSWPC		CDLF150-30-2FSWSC		30		
CDL150-30-1FSWPC		CDLF150-30-1FSWSC		37		
CDL150-30FSWPC		CDLF150-30FSWSC		37		
CDL150-40-2FSWPC	по запросу	CDLF150-40-2FSWSC	по запросу	45		
CDL150-40-1FSWPC		CDLF150-40-1FSWSC		45		
CDL150-40FSWPC		CDLF150-40FSWSC		55		
CDL150-50-2FSWPC		CDLF150-50-2FSWSC		55		
CDL150-50-1FSWPC		CDLF150-50-1FSWSC		75		
CDL150-50FSWPC		CDLF150-50FSWSC		75		
CDL150-60-2FSWPC		CDLF150-60-2FSWSC		75		
CDL150-60-1FSWPC		CDLF150-60-1FSWSC		75		
CDL150-60FSWPC		CDLF150-60FSWSC		75		
CDLF,CDL 200						
CDL200-10-BFSWPC		по запросу		CDLF200-10-BFSWSC	по запросу	18.5
CDL200-10-AFSWPC				CDLF200-10-AFSWSC		22
CDL200-10FSWPC				CDLF200-10FSWSC		30
CDL200-20-2BFSWPC	CDLF200-20-2BFSWSC		37			
CDL200-20-2AFSWPC	CDLF200-20-2AFSWSC		45			
CDL200-20-AFSWPC	CDLF200-20-AFSWSC		55			
CDL200-20FSWPC	CDLF200-20FSWSC		55			
CDL200-30-2BFSWPC	CDLF200-30-2BFSWSC		75			
CDL200-30-A-BFSWPC	CDLF200-30-A-BFSWSC		75			
CDL200-30-2AFSWPC	CDLF200-30-2AFSWSC		75			
CDL200-30-BFSWPC	CDLF200-30-BFSWSC		75			
CDL200-30-AFSWPC	CDLF200-30-AFSWSC		75			
CDL200-30FSWPC	CDLF200-30FSWSC		90			
CDL200-40-2BFSWPC	CDLF200-40-2BFSWSC		90			
CDL200-40-2AFSWPC	CDLF200-40-2AFSWSC		110			
CDL200-40-AFSWPC	CDLF200-40-AFSWSC		110			
CDL200-40FSWPC	CDLF200-40FSWSC		110			

CDLKF, CDLK

Полупогружные многоступенчатые насосы

CDLK F 32-120 / 12 - 2

F: модель из нерж. стали	Количество ступеней x10	Количество рабочих колёс
Номинальная подача, м ³ /ч	Количество уменьшенных колёс	
<p>CDLK – Вертикальный многоступенчатый полупогружной центробежный насос Материалы насосов: Диффузор, рабочее колесо всех типов насосов из нерж. стали 304/316L; Насосы CDLK - головная часть из чугуна HT200; Насосы CDLKF - головная часть из нерж. стали 304/316L;</p>		
<p>Цена насосов с электродвигателем IE3 рассчитывается как цена стандарт.насоса +5%</p>		

<p>S: стандартное исполнение (прайс) 3ф. До 3 кВт для 220/380В От 3 кВт для 380В</p> <p>D: 1ф. 220В</p> <p>B: только насосная часть</p> <p>Q: 3-х фазное, 1500об/мин</p> <p>Для насосов с однофазными двигателями (220В) цена насосов будет рассчитываться следующим образом: 0,37кВт, 0,55кВт на $\pm 10,0$ USD; 0,75кВт, 1,1кВт на $\pm 14,0$ USD; 1,5кВт на $\pm 20,0$ USD; 2,2кВт на $\pm 24,0$ USD.</p>	<p>Частота W: 50Гц (прайс) L: 60Гц</p>
<p>Проточная часть S: нерж.сталь SS304 (прайс) L: нерж.сталь SS316 (+ 30%, к цене насоса из нерж. ст. SS304.) P: чугун J: дуплекс нерж.сталь 904L A: дуплекс нерж.сталь 2507</p>	
<p>C: стандартный температурный режим (-15 град.С...+70 град.С) (прайс) R: высоко-температурное исполнение (-15 град.С...+105 град.С) (+ 5% к цене стд. насоса)</p>	

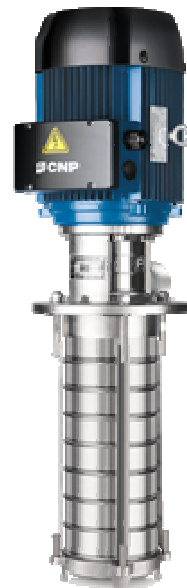

обновление
28.04.2022

Входная,выходная камеры - чугун		Входная,выходная камеры -нерж. SS304		Мощность (кВт)
Артикул	Цена розница (USD) с НДС	Артикул	Цена розница (USD) с НДС	
CDLK(F), CDLK1				
CDLK1-20/2SWPC	404.44	CDLKF1-20/2SWSC	502.51	0.37
CDLK1-30/3SWPC	439.67	CDLKF1-30/3SWSC	537.74	0.37
CDLK1-40/4SWPC	468.26	CDLKF1-40/4SWSC	566.32	0.37
CDLK1-50/5SWPC	519.50	CDLKF1-50/5SWSC	617.56	0.37
CDLK1-60/6SWPC	581.52	CDLKF1-60/6SWSC	679.59	0.37
CDLK1-70/7SWPC	621.43	CDLKF1-70/7SWSC	719.50	0.37
CDLK1-80/8SWPC	666.74	CDLKF1-80/8SWSC	764.80	0.55
CDLK1-90/9SWPC	689.39	CDLKF1-90/9SWSC	787.46	0.55
CDLK1-100/10SWPC	723.37	CDLKF1-100/10SWSC	821.43	0.55
CDLK1-110/11SWPC	741.98	CDLKF1-110/11SWSC	840.04	0.55
CDLK1-120/12SWPC	808.05	CDLKF1-120/12SWSC	906.11	0.75
CDLK1-130/13SWPC	825.31	CDLKF1-130/13SWSC	923.37	0.75

CDLK1-140/14SWPC	853.35	CDLKF1-140/14SWSC	951.42	0.75
CDLK1-150/15SWPC	870.61	CDLKF1-150/15SWSC	968.68	0.75
CDLK1-160/16SWPC	879.24	CDLKF1-160/16SWSC	977.31	1.1
CDLK1-170/17SWPC	887.33	CDLKF1-170/17SWSC	985.40	1.1
CDLK1-180/18SWPC	924.55	CDLKF1-180/18SWSC	1 022.61	1.1
CDLK1-190/19SWPC	961.23	CDLKF1-190/19SWSC	1 059.29	1.1
CDLK1-200/20SWPC	983.88	CDLKF1-200/20SWSC	1 081.94	1.1
CDLK1-210/21SWPC	1 019.94	CDLKF1-210/21SWSC	1 118.00	1.1/1.4
CDLK1-220/22SWPC	1 086.28	CDLKF1-220/22SWSC	1 184.34	1.1/1.4
CDLK1-230/23SWPC	1 093.90	CDLKF1-230/23SWSC	1 191.97	1.1/1.4
CDLK1-240/24SWPC	1 150.00	CDLKF1-240/24SWSC	1 248.06	1.5
CDLK1-250/25SWPC	1 160.79	CDLKF1-250/25SWSC	1 258.85	1.5
CDLK1-260/26SWPC	1 179.66	CDLKF1-260/26SWSC	1 277.73	1.5
CDLK1-270/27SWPC	1 213.50	CDLKF1-270/27SWSC	1 311.56	1.5/1.8
CDLK1-280/28SWPC	1 222.67	CDLKF1-280/28SWSC	1 320.73	1.5/1.8
CDLK1-290/29SWPC	1 231.84	CDLKF1-290/29SWSC	1 329.90	1.5/1.8
CDLK1-300/30SWPC	1 241.01	CDLKF1-300/30SWSC	1 339.07	1.5/1.8
CDLK1-310/31SWPC	1 346.32	CDLKF1-310/31SWSC	1 444.39	2.2
CDLK1-320/32SWPC	1 467.68	CDLKF1-320/32SWSC	1 565.74	2.2
CDLK1-330/33SWPC	1 588.49	CDLKF1-330/33SWSC	1 686.56	2.2
CDLK1-340/34SWPC	1 618.16	CDLKF1-340/34SWSC	1 716.22	2.2
CDLK1-350/35SWPC	1 647.82	CDLKF1-350/35SWSC	1 745.89	2.2
CDLK1-360/36SWPC	1 677.49	CDLKF1-360/36SWSC	1 775.55	2.2
CDLK(F), CDLK2				
CDLK2-20/2SWPC	391.13	CDLKF2-20/2SWSC	489.19	0.37
CDLK2-30/3SWPC	445.06	CDLKF2-30/3SWSC	543.13	0.37
CDLK2-40/4SWPC	520.03	CDLKF2-40/4SWSC	618.10	0.55
CDLK2-50/5SWPC	549.70	CDLKF2-50/5SWSC	647.76	0.55
CDLK2-60/6SWPC	626.29	CDLKF2-60/6SWSC	724.35	0.75
CDLK2-70/7SWPC	655.95	CDLKF2-70/7SWSC	754.02	0.75
CDLK2-80/8SWPC	678.60	CDLKF2-80/8SWSC	776.67	1.1
CDLK2-90/9SWPC	701.26	CDLKF2-90/9SWSC	799.32	1.1
CDLK2-100/10SWPC	758.43	CDLKF2-100/10SWSC	856.49	1.1
CDLK2-110/11SWPC	778.06	CDLKF2-110/11SWSC	876.12	1.1/1.4
CDLK2-120/12SWPC	839.33	CDLKF2-120/12SWSC	937.40	1.5
CDLK2-130/13SWPC	853.35	CDLKF2-130/13SWSC	951.42	1.5
CDLK2-140/14SWPC	876.01	CDLKF2-140/14SWSC	974.07	1.5
CDLK2-150/15SWPC	913.62	CDLKF2-150/15SWSC	1 011.68	1.5/1.8
CDLK2-160/16SWPC	938.96	CDLKF2-160/16SWSC	1 037.03	2.2
CDLK2-170/17SWPC	965.39	CDLKF2-170/17SWSC	1 063.46	2.2
CDLK2-180/18SWPC	974.59	CDLKF2-180/18SWSC	1 072.65	2.2
CDLK2-190/19SWPC	1 011.39	CDLKF2-190/19SWSC	1 109.45	2.2
CDLK2-200/20SWPC	1 042.13	CDLKF2-200/20SWSC	1 140.19	2.2
CDLK2-210/21SWPC	1 066.40	CDLKF2-210/21SWSC	1 164.46	2.2
CDLK2-220/22SWPC	1 091.04	CDLKF2-220/22SWSC	1 189.10	2.2/2.6
CDLK2-230/23SWPC	1 179.12	CDLKF2-230/23SWSC	1 277.19	3

CDLK2-240/24SWPC	1 203.93	CDLKF2-240/24SWSC	1 302.00	3
CDLK2-250/25SWPC	1 214.18	CDLKF2-250/25SWSC	1 312.25	3
CDLK2-260/26SWPC	1 224.43	CDLKF2-260/26SWSC	1 322.49	3
CDLK(F), CDLK3				
CDLK3-20/2SWPC	428.96	CDLKF3-20/2SWSC	527.02	0.37
CDLK3-30/3SWPC	468.26	CDLKF3-30/3SWSC	566.32	0.37
CDLK3-40/4SWPC	513.56	CDLKF3-40/4SWSC	611.63	0.37
CDLK3-50/5SWPC	553.47	CDLKF3-50/5SWSC	651.54	0.37
CDLK3-60/6SWPC	626.83	CDLKF3-60/6SWSC	724.89	0.55
CDLK3-70/7SWPC	649.48	CDLKF3-70/7SWSC	747.54	0.55
CDLK3-80/8SWPC	723.37	CDLKF3-80/8SWSC	821.43	0.75
CDLK3-90/9SWPC	751.42	CDLKF3-90/9SWSC	849.48	0.75
CDLK3-100/10SWPC	796.72	CDLKF3-100/10SWSC	894.79	0.75
CDLK3-110/11SWPC	836.63	CDLKF3-110/11SWSC	934.70	1.1
CDLK3-120/12SWPC	864.68	CDLKF3-120/12SWSC	962.75	1.1
CDLK3-130/13SWPC	893.27	CDLKF3-130/13SWSC	991.33	1.1
CDLK3-140/14SWPC	925.55	CDLKF3-140/14SWSC	1 023.62	1.1
CDLK3-150/15SWPC	971.32	CDLKF3-150/15SWSC	1 069.39	1.1/1.4
CDLK3-160/16SWPC	1 036.33	CDLKF3-160/16SWSC	1 134.40	1.5
CDLK3-170/17SWPC	1 053.45	CDLKF3-170/17SWSC	1 151.52	1.5
CDLK3-180/18SWPC	1 082.95	CDLKF3-180/18SWSC	1 181.01	1.5
CDLK3-190/19SWPC	1 127.74	CDLKF3-190/19SWSC	1 225.81	1.5/1.8
CDLK3-200/20SWPC	1 169.61	CDLKF3-200/20SWSC	1 267.68	2.2
CDLK3-210/21SWPC	1 193.15	CDLKF3-210/21SWSC	1 291.21	2.2
CDLK3-220/22SWPC	1 227.94	CDLKF3-220/22SWSC	1 326.00	2.2
CDLK3-230/23SWPC	1 262.72	CDLKF3-230/23SWSC	1 360.79	2.2
CDLK3-240/24SWPC	1 297.78	CDLKF3-240/24SWSC	1 395.85	2.2
CDLK3-250/25SWPC	1 332.84	CDLKF3-250/25SWSC	1 430.90	2.2
CDLK3-260/26SWPC	1 376.26	CDLKF3-260/26SWSC	1 474.32	2.2
CDLK3-270/27SWPC	1 440.51	CDLKF3-270/27SWSC	1 538.58	2.2/2.6
CDLK3-280/28SWPC	1 517.35	CDLKF3-280/28SWSC	1 615.41	2.2/2.6
CDLK3-290/29SWPC	1 593.69	CDLKF3-290/29SWSC	1 691.75	2.2/2.6
CDLK3-300/30SWPC	1 697.74	CDLKF3-300/30SWSC	1 795.80	3
CDLK3-310/31SWPC	1 720.63	CDLKF3-310/31SWSC	1 818.70	3
CDLK3-320/32SWPC	1 768.91	CDLKF3-320/32SWSC	1 866.97	3
CDLK3-330/33SWPC	1 817.18	CDLKF3-330/33SWSC	1 915.24	3
CDLK3-340/34SWPC	1 868.24	CDLKF3-340/34SWSC	1 966.30	3
CDLK3-350/35SWPC	1 919.29	CDLKF3-350/35SWSC	2 017.36	3
CDLK3-360/36SWPC	1 970.36	CDLKF3-360/36SWSC	2 068.42	3
CDLK(F), CDLK4				
CDLK4-20/2SWPC	440.21	CDLKF4-20/2SWSC	538.27	0.37
CDLK4-30/3SWPC	468.26	CDLKF4-30/3SWSC	566.32	0.55
CDLK4-40/4SWPC	555.09	CDLKF4-40/4SWSC	653.16	0.75
CDLK4-50/5SWPC	625.75	CDLKF4-50/5SWSC	723.81	1.1
CDLK4-60/6SWPC	668.90	CDLKF4-60/6SWSC	766.96	1.1

CDLK4-70/7SWPC	767.35	CDLKF4-70/7SWSC	865.42	1.5
CDLK4-80/8SWPC	780.00	CDLKF4-80/8SWSC	878.07	1.5
CDLK4-90/9SWPC	839.87	CDLKF4-90/9SWSC	937.94	2.2
CDLK4-100/10SWPC	860.91	CDLKF4-100/10SWSC	958.97	2.2
CDLK4-110/11SWPC	881.40	CDLKF4-110/11SWSC	979.47	2.2
CDLK4-120/12SWPC	922.74	CDLKF4-120/12SWSC	1 020.80	2.2/2.6
CDLK4-130/13SWPC	1 050.34	CDLKF4-130/13SWSC	1 148.41	3
CDLK4-140/14SWPC	1 058.31	CDLKF4-140/14SWSC	1 156.37	3
CDLK4-150/15SWPC	1 091.75	CDLKF4-150/15SWSC	1 189.81	3
CDLK4-160/16SWPC	1 123.03	CDLKF4-160/16SWSC	1 221.10	3
CDLK4-170/17SWPC	1 286.79	CDLKF4-170/17SWSC	1 384.85	4
CDLK4-180/18SWPC	1 340.93	CDLKF4-180/18SWSC	1 438.99	4
CDLK4-190/19SWPC	1 434.24	CDLKF4-190/19SWSC	1 532.30	4
CDLK4-200/20SWPC	1 502.74	CDLKF4-200/20SWSC	1 600.80	4
CDLK4-210/21SWPC	1 552.90	CDLKF4-210/21SWSC	1 650.96	4
CDLK4-220/22SWPC	1 670.43	CDLKF4-220/22SWSC	1 768.49	4/4.5
CDLK(F), CDLK8				
CDLK8-20/2SWPC	665.24	CDLKF8-20/2SWSC	844.63	0.75
CDLK8-30/3SWPC	732.39	CDLKF8-30/3SWSC	911.79	1.1
CDLK8-40/4SWPC	805.21	CDLKF8-40/4SWSC	984.61	1.5
CDLK8-50/5SWPC	890.96	CDLKF8-50/5SWSC	1 070.35	2.2
CDLK8-60/6SWPC	960.54	CDLKF8-60/6SWSC	1 139.96	2.2
CDLK8-70/7SWPC	1 141.76	CDLKF8-70/7SWSC	1 321.16	3
CDLK8-80/8SWPC	1 266.35	CDLKF8-80/8SWSC	1 445.75	3
CDLK8-90/9SWPC	1 447.91	CDLKF8-90/9SWSC	1 627.31	4
CDLK8-100/10SWPC	1 660.62	CDLKF8-100/10SWSC	1 840.02	4
CDLK8-110/11SWPC	1 801.93	CDLKF8-110/11SWSC	1 981.34	4
CDLK8-120/12SWPC	1 882.88	CDLKF8-120/12SWSC	2 062.29	4/4.5
CDLK8-130/13SWPC	2 100.73	CDLKF8-130/13SWSC	2 280.12	5.5
CDLK8-140/14SWPC	2 196.74	CDLKF8-140/14SWSC	2 376.13	5.5
CDLK8-150/15SWPC	2 231.79	CDLKF8-150/15SWSC	2 411.21	5.5
CDLK8-160/16SWPC	2 311.62	CDLKF8-160/16SWSC	2 491.01	5.5
CDLK8-170/17SWPC	2 456.17	CDLKF8-170/17SWSC	2 635.58	7.5
CDLK8-180/18SWPC	2 520.89	CDLKF8-180/18SWSC	2 700.27	7.5
CDLK8-190/19SWPC	2 593.16	CDLKF8-190/19SWSC	2 772.58	7.5
CDLK8-200/20SWPC	2 654.11	CDLKF8-200/20SWSC	2 833.51	7.5
CDLK(F), CDLK15				
CDLK15-20/2SWPC	988.88	CDLKF15-20/2SWSC	1 168.23	2.2
CDLK15-30/3SWPC	1 230.73	CDLKF15-30/3SWSC	1 410.12	3
CDLK15-40/4SWPC	1 418.79	CDLKF15-40/4SWSC	1 598.17	4
CDLK15-50/5SWPC	1 512.77	CDLKF15-50/5SWSC	1 692.13	4
CDLK15-60/6SWPC	1 863.41	CDLKF15-60/6SWSC	2 042.76	5.5
CDLK15-70/7SWPC	1 890.82	CDLKF15-70/7SWSC	2 070.21	5.5
CDLK15-80/8SWPC	2 103.75	CDLKF15-80/8SWSC	2 283.14	7.5
CDLK15-90/9SWPC	2 151.54	CDLKF15-90/9SWSC	2 330.93	7.5
CDLK15-100/10SWPC	2 577.84	CDLKF15-100/10SWSC	2 757.23	11

CDLK15-110/11SWPC	2 831.96	CDLKF15-110/11SWSC	3 011.31	11
CDLK15-120/12SWPC	2 934.09	CDLKF15-120/12SWSC	3 113.44	11
CDLK15-130/13SWPC	2 939.67	CDLKF15-130/13SWSC	3 119.02	11
CDLK15-140/14SWPC	3 074.32	CDLKF15-140/14SWSC	3 253.71	11
CDLK15-150/15SWPC	3 395.96	CDLKF15-150/15SWSC	3 575.35	15
CDLK15-160/16SWPC	3 523.53	CDLKF15-160/16SWSC	3 702.92	15
CDLK15-170/17SWPC	3 679.06	CDLKF15-170/17SWSC	3 847.22	15
CDLK(F), CDLK20				
CDLK20-20/2SWPC	1 272.87	CDLKF20-20/2SWSC	1 462.88	2.2
CDLK20-30/3SWPC	1 687.64	CDLKF20-30/3SWSC	1 877.64	4
CDLK20-40/4SWPC	1 994.53	CDLKF20-40/4SWSC	2 184.50	5.5
CDLK20-50/5SWPC	2 118.04	CDLKF20-50/5SWSC	2 308.03	5.5
CDLK20-60/6SWPC	2 405.52	CDLKF20-60/6SWSC	2 595.50	7.5
CDLK20-70/7SWPC	2 470.78	CDLKF20-70/7SWSC	2 660.75	7.5
CDLK20-80/8SWPC	2 818.12	CDLKF20-80/8SWSC	3 008.13	11
CDLK20-90/9SWPC	2 878.26	CDLKF20-90/9SWSC	3 068.26	11
CDLK20-100/10SWPC	2 938.40	CDLKF20-100/10SWSC	3 128.40	11
CDLK20-110/11SWPC	3 245.39	CDLKF20-110/11SWSC	3 435.38	15
CDLK20-120/12SWPC	3 429.21	CDLKF20-120/12SWSC	3 619.20	15
CDLK20-130/13SWPC	3 633.08	CDLKF20-130/13SWSC	3 823.07	15
CDLK20-140/14SWPC	3 836.96	CDLKF20-140/14SWSC	4 026.94	15
CDLK20-150/15SWPC	4 029.08	CDLKF20-150/15SWSC	4 219.08	18.5
CDLK20-160/16SWPC	4 115.59	CDLKF20-160/16SWSC	4 305.58	18.5
CDLK20-170/17SWPC	4 202.10	CDLKF20-170/17SWSC	4 392.08	18.5
CDLK(F), CDLK32				
CDLK32-10-1/1-1SWPC	1 517.50	CDLKF32-10-1/1-1SWSC	1 803.79	1.5
CDLK32-10/1SWPC	1 551.42	CDLKF32-10/1SWSC	1 837.71	2.2
CDLK32-20/2-2SWPC	1 816.96	CDLKF32-20/2-2SWSC	2 103.24	3
CDLK32-20/2SWPC	2 094.47	CDLKF32-20/2SWSC	2 380.76	4
CDLK32-30/3SWPC	2 493.12	CDLKF32-30/3SWSC	2 779.41	5.5
CDLK32-40/4SWPC	2 688.23	CDLKF32-40/4SWSC	2 974.52	7.5
CDLK32-50/5SWPC	3 067.70	CDLKF32-50/5SWSC	3 353.99	11
CDLK32-60/6SWPC	3 184.50	CDLKF32-60/6SWSC	3 470.79	11
CDLK32-70/7SWPC	3 672.21	CDLKF32-70/7SWSC	3 958.50	15
CDLK32-80/8SWPC	3 841.99	CDLKF32-80/8SWSC	4 128.28	15
CDLK32-90/9SWPC	4 344.31	CDLKF32-90/9SWSC	4 630.60	18.5
CDLK32-100/10SWPC	4 544.37	CDLKF32-100/10SWSC	4 830.66	18.5
CDLK32-110/11SWPC	5 227.28	CDLKF32-110/11SWSC	5 513.57	22
CDLK32-120/12SWPC	5 488.98	CDLKF32-120/12SWSC	5 775.27	22
CDLK32-130/13SWPC	7 117.03	CDLKF32-130/13SWSC	7 403.32	30
CDLK32-140/14SWPC	7 354.94	CDLKF32-140/14SWSC	7 641.23	30
CDLK(F), CDLK42				
CDLK42-10/1-1SWPC	2 043.58	CDLKF42-10/1-1SWSC	2 339.30	3
CDLK42-10/1SWPC	2 156.91	CDLKF42-10/1SWSC	2 452.64	4
CDLK42-20/2-2SWPC	2 885.67	CDLKF42-20/2-2SWSC	3 181.39	5.5
CDLK42-20 /2 SWPC	2 916.61	CDLKF42-20 /2 SWSC	3 212.33	7.5

CDLK42-30/3-2SWPC	3 841.75	CDLKF42-30/3-2SWSC	4 137.47	11
CDLK42 -30/3SWPC	3 841.75	CDLKF42 -30/3SWSC	4 137.47	11
CDLK42-40/4-2SWPC	5 431.42	CDLKF42-40/4-2SWSC	5 727.15	15
CDLK42-40/4SWPC	5 431.42	CDLKF42-40/4SWSC	5 727.15	15
CDLK42-50/5-2SWPC	6 310.07	CDLKF42-50/5-2SWSC	6 605.79	18.5
CDLK42-50/5SWPC	6 310.07	CDLKF42-50/5SWSC	6 605.79	18.5
CDLK42-60/6-2SWPC	7 023.52	CDLKF42-60/6-2SWSC	7 319.24	22
CDLK42-60 /6 SWPC	7 023.52	CDLKF42-60 /6 SWSC	7 319.24	22
CDLK42-70/7-2SWPC	8 153.33	CDLKF42-70/7-2SWSC	8 449.06	30
CDLK42-70/7SWPC	8 153.33	CDLKF42-70/7SWSC	8 449.06	30
CDLK42-80/8-2SWPC	8 451.26	CDLKF42-80/8-2SWSC	8 746.98	30
CDLK42-80 /8SWPC	8 451.26	CDLKF42-80 /8SWSC	8 746.98	30
CDLK42-90/9-2SWPC	8 873.00	CDLKF42-90/9-2SWSC	9 168.72	30
CDLK42-90 /9 SWPC	9 132.01	CDLKF42-90 /9 SWSC	9 427.73	37
CDLK42-100/10-2SWPC	9 557.54	CDLKF42-100/10-2SWSC	9 853.27	37
CDLK42-100/10 SWPC	9 557.54	CDLKF42-100/10 SWSC	9 853.27	37
CDLK42-110/11-2SWPC	12 712.56	CDLKF42-110/11-2SWSC	13 008.28	45
CDLK42-110/11 SWPC	12 712.56	CDLKF42-110/11 SWSC	13 008.28	45
CDLK42-120/12-2SWPC	13 048.33	CDLKF42-120/12-2SWSC	13 344.06	45
CDLK42-120 /12SWPC	13 048.33	CDLKF42-120 /12SWSC	13 344.06	45
CDLK42-130/13-2SWPC	13 381.41	CDLKF42-130/13-2SWSC	13 677.13	45



www.aikonrussia.ru
www.cnprussia.ru

CHL,CHLF(T) горизонтальные многоступенчатые центробежные насосы

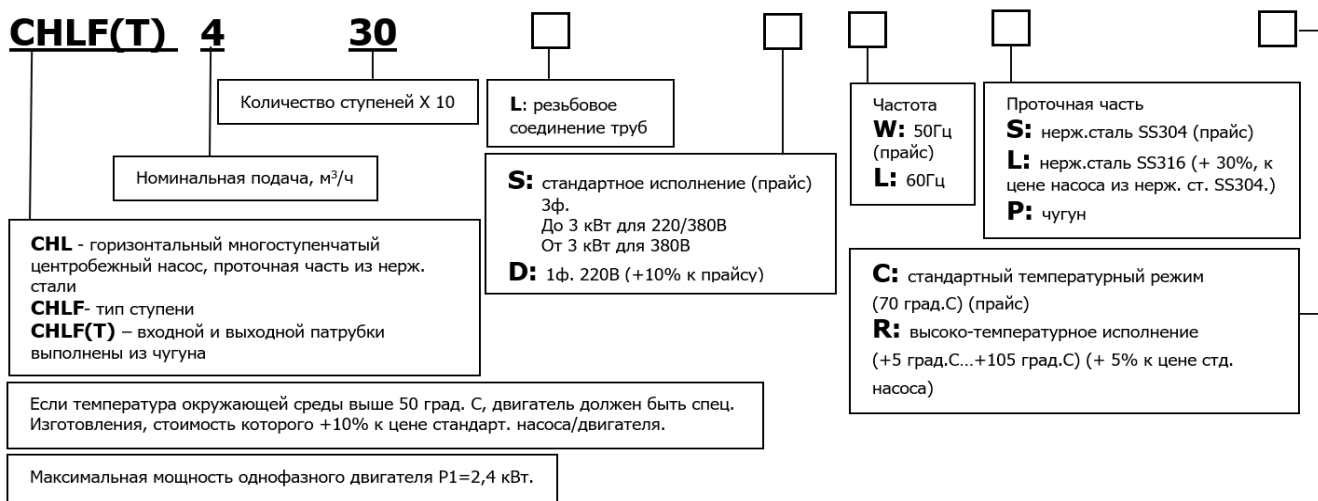

обновление
25.04.2021

Горизонтальные многоступенчатые центробежные насосы CHL 2 - 20

Проточн.часть -нерж. SS304		Мощность (кВт)
Артикул	Цена розница (USD) с НДС	
CHL 2-10LSWSC	221.07	0.37
CHL 2-20LSWSC	256.64	0.37
CHL 2-30LSWSC	266.81	0.37
CHL 2-40LSWSC	313.81	0.55
CHL 2-50LSWSC	377.34	0.55
CHL 2-60LSWSC	387.50	0.75

Проточн.часть -нерж. SS304		Мощность (кВт)
Артикул	Цена розница (USD) с НДС	
CHL 4-10LSWSC	261.72	0.37
CHL 4-20LSWSC	264.26	0.37
CHL 4-30LSWSC	296.03	0.55
CHL 4-40LSWSC	360.82	0.75

Проточн.часть -нерж. SS304		Мощность (кВт)
Артикул	Цена розница (USD) с НДС	
CHL 8-10LSWSC	565.37	0.75
CHL 8-20LSWSC	588.24	0.75

Проточн.часть -нерж. SS304		Мощность (кВт)
Артикул	Цена розница (USD) с НДС	
CHL12-10LSWSC	598.41	0.75
CHL12-20LSWSC	635.25	1.2

CHL 8-30LSWSC	633.98	1.1
CHL 8-40LSWSC	661.93	1.5
CHL 8-50LSWSC	785.17	2.2

CHL12-30LSWSC	795.33	1.8
CHL12-40LSWSC	872.83	2.4
CHL12-50LSWSC	1025.29	3

Проточн. часть -нерж. SS304		Мощность (кВт)
Артикул	Цена розница (USD) с НДС	
CHL 15-10LSWSC	752.97	1.1
CHL 15-20LSWSC	817.71	2.2
CHL 15-30LSWSC	998.25	3

Проточн. часть -нерж. SS304		Мощность (кВт)
Артикул	Цена розница (USD) с НДС	
CHL20-10LSWSC	731.81	1.1
CHL20-20LSWSC	805.50	2.2
CHL20-30LSWSC	1129.47	4



Горизонтальные многоступенчатые центробежные насосы CHLF(T) 2 - 20

CHLF патрубки - нерж. SS304		CHLF(T) патрубки - чугун		Мощность (кВт)
Артикул	Цена розница (USD) с НДС	Артикул	Цена розница (USD) с НДС	
CHLF2-20LSWSC	228.87	CHLFT2-20LSWPC	211.65	0.37
CHLF2-30LSWSC	249.79	CHLFT2-30LSWPC	222.72	0.37
CHLF2-40LSWSC	280.56	CHLFT2-40LSWPC	258.41	0.55
CHLF2-50LSWSC	371.61	CHLFT2-50LSWPC	338.39	0.55
CHLF2-60LSWSC	380.23	CHLFT2-60LSWPC	348.23	0.75

CHLF патрубки - нерж. SS304		CHLF(T) патрубки - чугун		Мощность (кВт)
Артикул	Цена розница (USD) с НДС	Артикул	Цена розница (USD) с НДС	
CHLF4-20LSWSC	248.56	CHLFT4-20LSWPC	233.80	0.37
CHLF4-30LSWSC	326.08	CHLFT4-30LSWPC	286.71	0.55
CHLF4-40LSWSC	340.85	CHLFT4-40LSWPC	310.09	0.75
CHLF4-50LSWSC	401.15	CHLFT4-50LSWPC	390.07	1.1
CHLF4-60LSWSC	418.37	CHLFT4-60LSWPC	410.99	1.1

CHLF патрубки - нерж. SS304		CHLF(T) патрубки - чугун		Мощность (кВт)
Артикул	Цена розница (USD) с НДС	Артикул	Цена розница (USD) с НДС	
CHLF8-10LSWSC	582.03	CHLFT8-10LSWPC	484.82	0.75
CHLF8-20LSWSC	605.41	CHLFT8-20LSWPC	509.43	0.75
CHLF8-30LSWSC	653.40	CHLFT8-30LSWPC	557.42	1.1
CHLF8-40LSWSC	738.31	CHLFT8-40LSWPC	642.33	1.5
CHLF8-50LSWSC	808.44	CHLFT8-50LSWPC	712.46	2.2

CHLF патрубки - нерж. SS304		CHLF(T) патрубки - чугун		Мощность (кВт)
Артикул	Цена розница (USD) с НДС	Артикул	Цена розница (USD) с НДС	
CHLF12-10LSWSC	591.87	CHLFT12-10LSWPC	494.66	0.75
CHLF12-20LSWSC	641.09	CHLFT12-20LSWPC	542.65	1.2
CHLF12-30LSWSC	841.67	CHLFT12-30LSWPC	745.69	1.8

CHLF12-40LSWSC	933.96	CHLFT12-40LSWPC	836.75	2.4
CHLF12-50LSWSC	1119.76	CHLFT12-50LSWPC	1023.78	3

CHLF патрубки -нерж. SS304		CHLF(T) патрубки - чугун		Мощность (кВт)
Артикул	Цена розница (USD) с НДС	Артикул	Цена розница (USD) с НДС	
CHLF15-10LSWSC	829.06	CHLFT15-10LSWPC	723.01	1.1
CHLF15-20LSWSC	870.78	CHLFT15-20LSWPC	764.69	2.2
CHLF15-30LSWSC	1062.63	CHLFT15-30LSWPC	956.18	3
CHLF15-40LSWSC	1293.40	CHLFT15-40LSWPC	1187.34	4

CHLF патрубки -нерж. SS304		CHLF(T) патрубки - чугун		Мощность (кВт)
Артикул	Цена розница (USD) с НДС	Артикул	Цена розница (USD) с НДС	
CHLF20-10LSWSC	798.60	CHLFT20-10LSWPC	701.39	1.1
CHLF20-20LSWSC	831.82	CHLFT20-20LSWPC	733.38	2.2
CHLF20-30LSWSC	1096.38	CHLFT20-30LSWPC	999.17	4
CHLF20-40LSWSC	1305.57	CHLFT20-40LSWPC	1208.36	4.4



СНМ горизонтальные многоступенчатые центробежные насосы

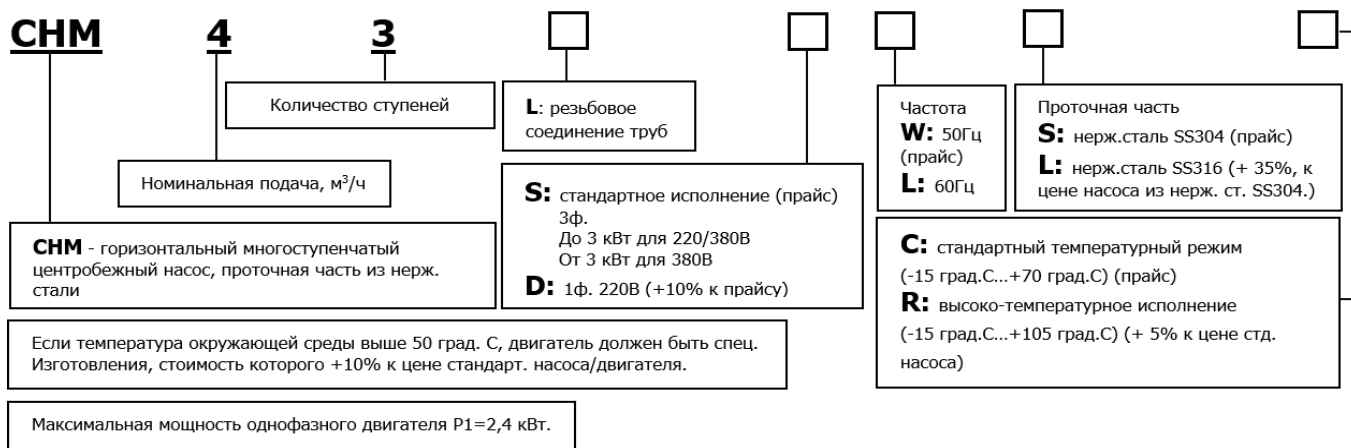

обновление
25.04.2021

Горизонтальные многоступенчатые центробежные насосы СНМ 1 - 20

Модель/Артикул	Мощность (кВт)	Цена розница (USD) с НДС
СНМ1-20LSWSC	0.37	282.21
СНМ1-30LSWSC	0.37	288.32
СНМ1-40LSWSC	0.37	303.37
СНМ1-50LSWSC	0.37	316.81
СНМ1-60LSWSC	0.37	351.83
СНМ1-70LSWSC	0.37	453.23
СНМ1-80LSWSC	0.55	499.23
СНМ1-90LSWSC	0.55	518.39

Модель/Артикул	Мощность (кВт)	Цена розница (USD) с НДС
СНМ3-20LSWSC	0.37	353.47
СНМ3-30LSWSC	0.37	360.78
СНМ3-40LSWSC	0.37	403.55
СНМ3-50LSWSC	0.55	450.39
СНМ3-60LSWSC	0.55	468.28
СНМ3-70LSWSC	0.75	521.23
СНМ3-80LSWSC	0.75	539.55
СНМ3-90LSWSC	1.1	622.63

Модель/Артикул	Мощность (кВт)	Цена розница (USD) с НДС
СНМ5-20LSWSC	0.37	348.18
СНМ5-30LSWSC	0.55	404.35
СНМ5-40LSWSC	0.55	438.15
СНМ5-50LSWSC	0.75	491.09
СНМ5-60LSWSC	1.1	575.37
СНМ5-70LSWSC	1.1	604.29
СНМ5-80LSWSC	1.1	627.09

Модель/Артикул	Мощность (кВт)	Цена розница (USD) с НДС
СНМ10-10LSWSC	0.75	656.01
СНМ10-20LSWSC	0.75	662.95
СНМ10-30LSWSC	1.1	728.11
СНМ10-40LSWSC	1.5	817.69
СНМ10-50LSWSC	2.2	882.85
СНМ10-60LSWSC	2.2	968.74
СНМ10-70LSWSC	3	1249.73
СНМ10-80LSWSC	3	1284.36
СНМ10-90LSWSC	4	1462.29

Модель/Артикул	Мощность (кВт)	Цена розница (USD) с НДС
CHM15-10LSWSC	1.1	840.88
CHM15-20LSWSC	2.2	1049.79
CHM15-30LSWSC	3	1303.48
CHM15-40LSWSC	4	1410.57
CHM15-50LSWSC	4	1453.34
CHM15-60LSWSC	4.8	1575.90

Модель/Артикул	Мощность (кВт)	Цена розница (USD) с НДС
CHM20-10LSWSC	1.1	805.48
CHM20-20LSWSC	2.2	1055.09
CHM20-30LSWSC	4	1518.50
CHM20-40LSWSC	4.8	1626.01
CHM20-50LSWSC	5.5	1708.64
CHM20-60LSWSC	7.5	1798.25



TD одноступенчатые циркуляционные насосы типа "ин-лайн"

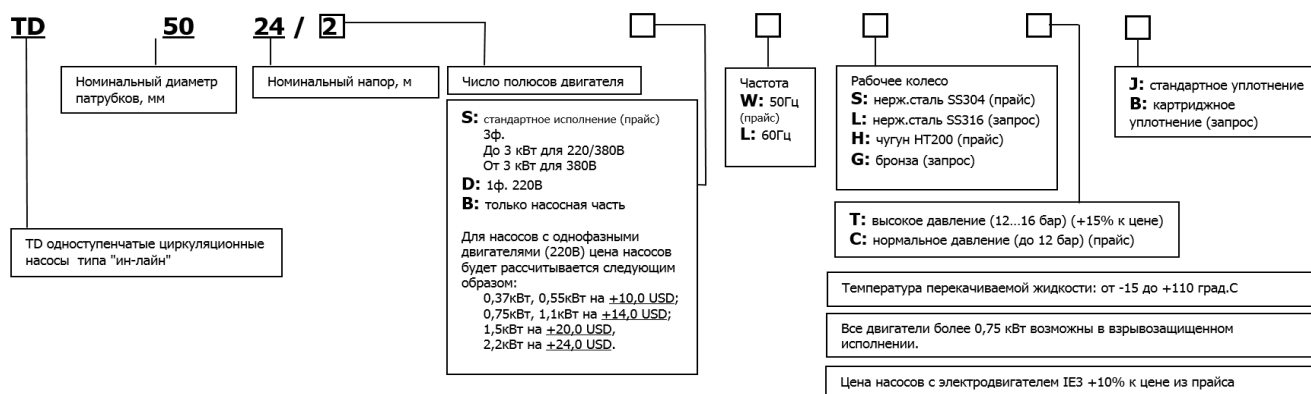

обновление 25.04.2022

Одноступенчатые циркуляционные насосы TD 32-65

Старая модель	Новая модель	Мощность (кВт)	рабоч.колесо нерж.ст.SS304		рабоч.колесо -чугун HT200	
			Артикул	Цена розница (USD) с НДС	Артикул	Цена розница (USD) с НДС
Одноступенчатые циркуляционные насосы TD 32-65						
TD32-6(l)/2		0.25	TD32-6(l)/2SWSCJ	410.37	---	---
TD32-10(l)/2		0.37	TD32-10(l)/2SWSCJ	537.42	---	---
TD50-6(l)/2		0.37	TD50-6(l)/2SWSCJ	600.95	---	---
TD50-11(l)/2		0.75	TD50-11(l)/2SWSCJ	665.74	---	---
TD32-14/2		0.75	TD32-14G/2SWSCJ	673.37	TD32-14G/2SWHCJ	604.76
TD32-18/2	TD32-18G/2	1.1	TD32-18G/2SWSCJ	673.37	TD32-18G/2SWHCJ	604.76
TD32-21/2	TD32-21G/2	1.5	TD32-21G/2SWSCJ	747.05	TD32-21G/2SWHCJ	674.64
TD32-25/2	TD32-26G/2	2.2	TD32-26G/2SWSCJ	787.71	TD32-26G/2SWHCJ	714.02
TD32-32/2	TD32-33G/2	3	TD32-33G/2SWSCJ	928.74	TD32-33G/2SWHCJ	848.69
TD32-38/2	TD32-40G/2	4	TD32-40G/2SWSCJ	1139.64	TD32-40G/2SWHCJ	1021.48
TD32-50/2	TD32-50G/2	5.5	TD32-50G/2SWSCJ	1444.56	TD32-50G/2SWHCJ	1311.16
	TD40-14G/2	0.75	TD40-14G/2SWSCJ	555.24	TD40-14G/2SWHCJ	503.08
TD40-16/2	TD40-16G/2	1.1	TD40-16G/2SWSCJ	606.03	TD40-16G/2SWHCJ	550.13
TD40-20/2	TD40-21G/2	1.5	TD40-21G/2SWSCJ	678.45	TD40-21G/2SWHCJ	617.46
TD40-18/2	TD40-20G/2	2.2	TD40-20G/2SWSCJ	757.22	TD40-20G/2SWHCJ	689.88
TD40-25/2	TD40-26G/2	3	TD40-26G/2SWSCJ	955.42	TD40-26G/2SWHCJ	849.96
TD40-30/2	TD40-30G/2	4	TD40-30G/2SWSCJ	1090.09	TD40-30G/2SWHCJ	978.29
TD40-36/2	TD40-36G/2	5.5	TD40-36G/2SWSCJ	1459.80	TD40-36G/2SWHCJ	1320.05
TD40-48/2	TD40-48G/2	7.5	TD40-48G/2SWSCJ	1495.38	TD40-48G/2SWHCJ	1359.44
TD50-12/2	TD50-12G/2	1.1	TD50-12G/2SWSCJ	707.67	TD50-12G/2SWHCJ	639.06
TD50-15/2	TD50-15G/2	1.5	TD50-15G/2SWSCJ	783.90	TD50-15G/2SWHCJ	711.48
TD50-18/2	TD50-18G/2	2.2	TD50-18G/2SWSCJ	824.55	TD50-18G/2SWHCJ	750.87
TD50-24/2	TD50-24G/2	3	TD50-24G/2SWSCJ	965.58	TD50-24G/2SWHCJ	886.81
TD50-28/2	TD50-28G/2	4	TD50-28G/2SWSCJ	1116.77	TD50-28G/2SWHCJ	1018.94

TD50-32/2	TD50-32G/2	3	TD50-32G/2SWSCJ	1043.05	TD50-32G/2SWHCJ	933.21
TD50-38/2	TD50-39G/2	4	TD50-39G/2SWSCJ	1187.45	TD50-39G/2SWHCJ	1074.21
TD50-48/2	TD50-49G/2	5.5	TD50-49G/2SWSCJ	1476.24	TD50-49G/2SWHCJ	1364.68
TD50-58/2	TD50-59G/2	7.5	TD50-59G/2SWSCJ	1677.84	TD50-59G/2SWHCJ	1506.84
TD50-80/2	TD50-80G/2	11	TD50-80G/2SWSCJ	2227.67	TD50-80G/2SWHCJ	2039.69
TD50-35/2	TD50-35G/2	5.5	TD50-35G/2SWSCJ	1396.28	TD50-35G/2SWHCJ	1288.29
TD50-40/2	TD50-40G/2	7.5	TD50-40G/2SWSCJ	1607.18	TD50-40G/2SWHCJ	1431.85
TD50-50/2	TD50-50G/2	11	TD50-50G/2SWSCJ	2143.33	TD50-50G/2SWHCJ	1943.87
TD50-60/2	TD50-60G/2	15	TD50-60G/2SWSCJ	2298.33	TD50-60G/2SWHCJ	2091.24
TD50-70/2	TD50-70G/2	18.5	TD50-70G/2SWSCJ	2446.98	TD50-70G/2SWHCJ	2203.05
TD50-81/2	TD50-81G/2	22	TD50-81G/2SWSCJ	2923.42	TD50-81G/2SWHCJ	2659.16
TD65-15/2	TD65-15G/2	2.2	TD65-15G/2SWSCJ	871.56	TD65-15G/2SWHCJ	766.11
TD65-19/2	TD65-20G/2	3	TD65-20G/2SWSCJ	1015.13	TD65-20G/2SWHCJ	902.06
TD65-22/2	TD65-22G/2	4	TD65-22G/2SWSCJ	1151.07	TD65-22G/2SWHCJ	1032.92
TD65-30/2	TD65-30G/2	5.5	TD65-30G/2SWSCJ	1431.85	TD65-30G/2SWHCJ	1300.99
TD65-36/2	TD65-37G/2	5.5	TD65-37G/2SWSCJ	1502.85	TD65-37G/2SWHCJ	1378.86
TD65-34/2	TD65-34G/2	7.5	TD65-34G/2SWSCJ	1467.43	TD65-34G/2SWHCJ	1334.03
TD65-40/2	TD65-41G/2	11	TD65-41G/2SWSCJ	2163.66	TD65-41G/2SWHCJ	1957.84
TD65-48/2	TD65-48G/2	7.5	TD65-48G/2SWSCJ	1540.79	TD65-48G/2SWHCJ	1412.25
TD65-50/2	TD65-51G/2	15	TD65-51G/2SWSCJ	2313.58	TD65-51G/2SWHCJ	2102.68
TD65-61/2	TD65-61G/2	18.5	TD65-61G/2SWSCJ	2433.01	TD65-61G/2SWHCJ	2217.02
TD65-67/2	TD65-68G/2	22	TD65-68G/2SWSCJ	2948.83	TD65-68G/2SWHCJ	2682.03
TD65-83/2	TD65-85G/2	30	TD65-85G/2SWSCJ	3840.72	TD65-85G/2SWHCJ	3529.45
Одноступенчатые циркуляционные насосы TD 80-150						
Старая модель	Новая модель	Мощность (кВт)	рабоч.колесо нерж.ст.SS304		рабоч.колесо -чугун HT200	
			Артикул	Цена розница (USD) с НДС	Артикул	Цена розница (USD) с НДС
TD80-13/2	TD80-13G/2	3	TD80-13G/2SWSCJ	1072.30	TD80-13G/2SWHCJ	961.77
TD80-18/2	TD80-18G/2	4	TD80-18G/2SWSCJ	1206.98	TD80-18G/2SWHCJ	1091.36
TD80-22/2	TD80-23G/2	5.5	TD80-23G/2SWSCJ	1490.30	TD80-23G/2SWHCJ	1361.98
TD80-28/2	TD80-29G/2	7.5	TD80-29G/2SWSCJ	1525.87	TD80-29G/2SWHCJ	1395.01
TD80-30/2	TD80-32G/2	11	TD80-32G/2SWSCJ	2239.89	TD80-32G/2SWHCJ	2015.01
TD80-38/2	TD80-38G/2	15	TD80-38G/2SWSCJ	2388.54	TD80-38G/2SWHCJ	2157.31
TD80-40/2	TD80-41G/2	11	TD80-41G/2 SWSCJ	2116.65	TD80-41G/2 SWHCJ	1974.36
TD80-48/2	TD80-48G/2	15	TD80-48G/2 SWSCJ	2274.20	TD80-48G/2 SWHCJ	2125.55
TD80-47/2	TD80-47G/2	18.5	TD80-47G/2SWSCJ	2509.24	TD80-47G/2SWHCJ	2270.38
TD80-54/2	TD80-54G/2	22	TD80-54G/2SWSCJ	2984.40	TD80-54G/2SWHCJ	2726.49
TD80-67/2	TD80-67G/2	30	TD80-67G/2SWSCJ	3873.75	TD80-67G/2SWHCJ	3572.65
TD100-9/2	не изм.	2.2	TD100-9/2SWSCJ	851.24	TD100-9/2SWHCJ	790.25
TD100-15/2		4	TD100-15/2SWSCJ	1124.39	TD100-15/2SWHCJ	1051.97
TD100-17/2	TD100-17G/2	5.5	TD100-17G/2SWSCJ	1537.31	TD100-17G/2SWHCJ	1415.34
TD100-22/2	TD100-22G/2	7.5	TD100-22G/2SWSCJ	1572.88	TD100-22G/2SWHCJ	1450.91
TD100-27/2	не изм.	11	TD100-27/2 SWSCJ	2225.92	TD100-27/2 SWHCJ	2065.83
TD100-33/2		15	TD100-33/2 SWSCJ	2426.66	TD100-33/2 SWHCJ	2217.02
TD100-40/2	TD100-40G/2	18.5	TD100-40G/2SWSCJ	2542.27	TD100-40G/2SWHCJ	2321.20
TD100-48/2	TD100-48G/2	22	TD100-48G/2SWSCJ	3019.98	TD100-48G/2SWHCJ	2776.04
TD100-52/2	TD100-52G/2	30	TD100-52G/2SWSCJ	3878.84	TD100-52G/2SWHCJ	3596.79
TD125-11/4	TD125-11G/4	5.5	TD125-11G/4SWSCJ	2147.15	TD125-11G/4SWHCJ	1914.64
TD125-14/4	TD125-14G/4	7.5	TD125-14G/4SWSCJ	2211.94	TD125-14G/4SWHCJ	1978.17
TD125-18/4	TD125-19G/4	11	TD125-19G/4 SWSCJ	2924.69	TD125-19G/4 SWHCJ	2852.27
TD125-22/4	TD125-22G/4	15	TD125-22G/4 SWSCJ	3685.72	TD125-22G/4 SWHCJ	3227.07
TD125-28/4	TD125-28G/4	18.5	TD125-28G/4 SWSCJ	4138.02	TD125-28G/4 SWHCJ	3657.77
TD125-32/4	TD125-32G/4	22	TD125-32G/4 SWSCJ	4282.86	TD125-32G/4 SWHCJ	3796.25
TD125-40/4	TD125-40G/4	30	TD125-40G/4SWSCJ	5126.47	TD125-40G/4SWHCJ	4601.75
TD125-48/4	TD125-48G/4	37	TD125-48G/4SWSCJ	5567.33	TD125-48G/4SWHCJ	5402.17
TD150-12.5/4	TD150-12.5G/4	11	TD150-12.5G/4 SWSCJ	3183.87	TD150-12.5G/4 SWHCJ	2976.78
TD150-17/4	TD150-17G/4	15	TD150-17G/4 SWSCJ	3365.55	TD150-17G/4 SWHCJ	3157.19

TD150-21/4	TD150-22G/4	18.5	TD150-22G/4 SWSCJ	3857.24	TD150-22G/4 SWHCJ	3648.88
TD150-25/4	не изм.	22	TD150-25/4SWSCJ	4153.26	TD150-25/4SWHCJ	3869.94
TD150-33/4		30	TD150-33/4SWSCJ	5018.48	TD150-33/4SWHCJ	4735.15
TD150-40/4		37	TD150-40/4SWSCJ	5849.38	TD150-40/4SWHCJ	5502.54
TD150-50/4		45	TD150-50/4SWSCJ	6823.86	TD150-50/4SWHCJ	6475.74

Одноступенчатые циркуляционные насосы TD 200-350

Старая модель	Новая модель	Мощность (кВт)	рабоч.колесо -нерж.ст.SS304		рабоч.колесо -чугун HT200	
			Артикул	Цена розница (USD) с НДС	Артикул	Цена розница (USD) с НДС
TD200-16/4	не изм.	18.5	TD200-16/4SWSCB	5368.73	TD200-16/4SWHCB	5006.88
TD200-19/4		22	TD200-19/4SWSCB	5449.14	TD200-19/4SWHCB	5087.29
TD200-24/4		30	TD200-24/4SWSCB	6686.64	TD200-24/4SWHCB	6315.66
TD200-31/4		37	TD200-31/4SWSCB	7312.71	TD200-31/4SWHCB	6868.77
TD200-36/4		45	TD200-36/4SWSCB	8456.55	TD200-36/4SWHCB	7851.23
TD200-47/4		55	TD200-47/4SWSCB	по запросу	TD200-47/4SWHCB	по запросу
TD200-53/4		75	TD200-53/4SWSCB		TD200-53/4SWHCB	
TD200-12.5/4		22	TD200-12.5/4SWSCB	5442.82	TD200-12.5/4SWHCB	5080.73
TD200-20/4		30	TD200-20/4SWSCB	6296.60	TD200-20/4SWHCB	5934.51
TD200-23/4		37	TD200-23/4SWSCB	7304.10	TD200-23/4SWHCB	6860.70
TD200-27/4		45	TD200-27/4SWSCB	8446.28	TD200-27/4SWHCB	7841.53
TD200-32/4		55	TD200-32/4SWSCB	по запросу	TD200-32/4SWHCB	по запросу
TD200-43/4		75	TD200-43/4SWSCB		TD200-43/4SWHCB	
TD200-50/4		90	TD200-50/4SWSCB		TD200-50/4SWHCB	
TD200-53/4		75	TD200-53/4SWSCB		TD200-53/4SWHCB	

Старая модель	Новая модель	Мощность (кВт)	рабоч.колесо -нерж.ст.SS304		рабоч.колесо -чугун HT200	
			Артикул	Цена розница (USD) с НДС	Артикул	Цена розница (USD) с НДС
TD250-16/4	не изм.	30	TD250-16/4SWSCB	7243.05	TD250-16/4SWHCB	6636.02
TD250-19/4		37	TD250-19/4SWSCB	7684.19	TD250-19/4SWHCB	7063.54
TD250-22/4		45	TD250-22/4SWSCB	8859.74	TD250-22/4SWHCB	8127.01
TD250-29/4		55	TD250-29/4SWSCB	по запросу	TD250-29/4SWHCB	по запросу
TD250-36/4		75	TD250-36/4SWSCB		TD250-36/4SWHCB	
TD250-47/4		90	TD250-47/4SWSCB		TD250-47/4SWHCB	
TD250-56/4		110	TD250-56/4SWSCB		TD250-56/4SWHCB	
TD250-12.5/4		30	TD250-12.5/4SWSCB	7234.23	TD250-12.5/4SWHCB	6628.20
TD250-14/4		37	TD250-14/4SWSCB	7675.09	TD250-14/4SWHCB	7055.09
TD250-17/4		45	TD250-17/4SWSCB	8849.03	TD250-17/4SWHCB	8115.95
TD250-20/4		55	TD250-20/4SWSCB	по запросу	TD250-20/4SWHCB	по запросу
TD250-26/4		75	TD250-26/4SWSCB		TD250-26/4SWHCB	
TD250-32/4		90	TD250-32/4SWSCB		TD250-32/4SWHCB	
TD250-40/4		110	TD250-40/4SWSCB		TD250-40/4SWHCB	
TD250-50/4		132	TD250-50/4SWSCB		TD250-50/4SWHCB	

Старая модель	Новая модель	Мощность (кВт)	рабоч.колесо -нерж.ст.SS304		рабоч.колесо -чугун HT200	
			Артикул	Цена розница (USD) с НДС	Артикул	Цена розница (USD) с НДС
TD300-15/4	не изм.	55	---	---	TD300-15/4SWHCB	по запросу
TD300-20/4		75	---	---	TD300-20/4SWHCB	
TD300-25/4		90	---	---	TD300-25/4SWHCB	
TD300-30/4		110	---	---	TD300-30/4SWHCB	
TD300-35/4		132	---	---	TD300-35/4SWHCB	
TD300-44/4		160	---	---	TD300-44/4SWHCB	
TD300-55/4		200	---	---	TD300-55/4SWHCB	

Старая модель	Новая модель	Мощность (кВт)	рабоч.колесо -нерж.ст.SS304		рабоч.колесо -чугун HT200	
			Артикул	Цена розница (USD) с НДС	Артикул	Цена розница (USD) с НДС
TD300-15(l)/4	не изм.	45	TD300-15(l)/4SWSCB	11472.62	---	---
TD300-18(l)/4		55	TD300-18(l)/4SWSCB	по запросу	---	---
TD300-21(l)/4		75	TD300-21(l)/4SWSCB		---	---
TD300-30(l)/4		90	TD300-30(l)/4SWSCB		---	---
TD300-36(l)/4		110	TD300-36(l)/4SWSCB		---	---
TD350-18(l)/4		75	TD350-18(l)/4SWSCB		---	---
TD350-20(l)/4		90	TD350-20(l)/4SWSCB		---	---
TD350-23(l)/4		110	TD350-23(l)/4SWSCB		---	---
Насосные агрегаты комплектуются двигателями с классом защиты IP55 в стандартном исполнении (по цене агрегата с двигателем IP54)!!!						



Циркуляционные насосы с "мокрым ротором" CMS(L) Aikon

обновление
01.07.2022

Модель/арт.	DN входного/выходного патрубка (фланец), мм	Напряжение, В	Максимальный расход, л/мин	Максимальный напор, м	Мощность, Вт	Масса, кг	Цена розница (USD) с НДС
CMS(L)40-8-370	40	3*380	145	8	370	7.5	391
CMS(L)40-13-550	40		180	13	550	8.5	429
CMS(L)40-19-1000	40		250	19	1000	16.5	858
CMS(L)50-14-1000	50		450	14	1000	16.5	704
CMS(L)50-18-1300	50		450	18	1300	22	858



SJ многоступенчатые погружные насосы из нержавеющей стали

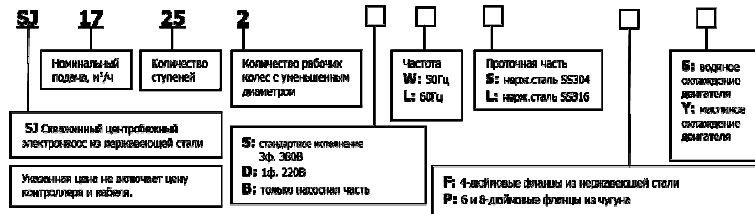

1. Цены в прайсе даны для насосов с двигателем **50Гц/ 380В**. Возможно исполнение насосов с однофазным и трехфазным двигателем.
2. Указанная цена не включает цену контролера и кабеля.
3. Для всех типов насосов рабочее колесо изготовлено из **нержавеющей стали**.
5. Для насосов SJ с 4 дюймовым двигателем, материал крышки двигателя и основание из **меди**. Для двигателей из нержавеющей стали цены предоставляются по запросу.
6. Для насосов SJ с 6 и 8 дюймовым двигателем, материал крышки двигателя и основание **чугунные**. Для двигателей из нержавеющей стали цены по запросу.
7. Стоимость насоса SJ в исполнении из нерж.стали SS316 формируется как цена насоса из SS304 +60%.
8. С 01.09.2020г. Насосы с 4,6" двигателями СТАНДАРТНО поставляются маслозаполненными, с 8" и более - с водяным охлаждением двигателя.

9. ВАЖНО!!! Перед погружением агрегата с водяным охлаждением двигателя необходимо полностью заполнить электродвигатель дистиллированной водой (артикул с литерой S).

10. Насосы SJ с 4" с маслозаполняемым двигателем могут быть изготовлены вертикального и горизонтального исполнения. Насосы SJ с 6" с маслозаполняемым двигателем мощностью до 26 кВт могут быть изготовлены вертикального и горизонтального исполнения, более только вертикального. Насосы SJ с 6" с водозаполняемым двигателем мощностью от 3-х до 11 кВт могут быть изготовлены вертикального и горизонтального исполнения, от 13 до 45 кВт только вертикального. Насосы SJ с 8" с водозаполняемым двигателем мощностью от 9,2-х до 55 кВт могут быть изготовлены вертикального и горизонтального исполнения, от 64 до 110 кВт только вертикального.

обновление 25.04.2022

Многоступенчатые погружные насосы из нержавеющей стали SJ 1				
4 дюймовый двигатель		6 дюймовый двигатель		Мощность (кВт)
Артикул	Цена розница (USD) с НДС	Артикул	Цена розница (USD) с НДС	
SJ1-1SWSF4Y	451.85	-----	-----	0.37
SJ1-2SWSF4Y	464.70	-----	-----	0.37
SJ1-3SWSF4Y	477.56	-----	-----	0.37
SJ1-4SWSF4Y	490.41	-----	-----	0.37
SJ1-5SWSF4Y	503.26	-----	-----	0.37
SJ1-6SWSF4Y	516.13	-----	-----	0.37
SJ1-7SWSF4Y	529.33	-----	-----	0.37
SJ1-8SWSF4Y	542.19	-----	-----	0.37
SJ1-9SWSF4Y	555.04	-----	-----	0.37
SJ1-10SWSF4Y	567.89	-----	-----	0.55
SJ1-11SWSF4Y	580.75	-----	-----	0.55
SJ1-12SWSF4Y	593.95	-----	-----	0.55
SJ1-13SWSF4Y	607.49	-----	-----	0.55
SJ1-14SWSF4Y	657.74	-----	-----	0.75
SJ1-15SWSF4Y	670.59	-----	-----	0.75
SJ1-16SWSF4Y	683.81	-----	-----	0.75
SJ1-17SWSF4Y	696.66	-----	-----	0.75
SJ1-18SWSF4Y	740.64	-----	-----	1.1
SJ1-19SWSF4Y	754.86	-----	-----	1.1
SJ1-20SWSF4Y	767.71	-----	-----	1.1
SJ1-21SWSF4Y	780.92	-----	-----	1.1
SJ1-22SWSF4Y	793.77	-----	-----	1.1
SJ1-23SWSF4Y	806.62	-----	-----	1.1

SJ1-24SWSF4Y	819.48	-----	-----	1.1
SJ1-25SWSF4Y	832.33	-----	-----	1.1
SJ1-26SWSF4Y	889.16	-----	-----	1.5
SJ1-27SWSF4Y	902.02	-----	-----	1.5
SJ1-28SWSF4Y	914.87	-----	-----	1.5
SJ1-29SWSF4Y	927.72	-----	-----	1.5
SJ1-30SWSF4Y	940.58	-----	-----	1.5
SJ1-31SWSF4Y	953.78	-----	-----	1.5
SJ1-32SWSF4Y	966.64	-----	-----	1.5
SJ1-33SWSF4Y	984.52	-----	-----	1.5
SJ1-34SWSF4Y	997.37	-----	-----	1.5
SJ1-35SWSF4Y	1 010.22	-----	-----	1.5
SJ1-36SWSF4Y	1 023.43	-----	-----	1.5
SJ1-37SWSF4Y	1 135.92	-----	-----	2.2
SJ1-38SWSF4Y	1 148.79	-----	-----	2.2
SJ1-39SWSF4Y	1 161.64	-----	-----	2.2
SJ1-40SWSF4Y	1 174.84	-----	-----	2.2
SJ1-41SWSF4Y	1 187.69	-----	-----	2.2
SJ1-42SWSF4Y	1 200.55	-----	-----	2.2
SJ1-43SWSF4Y	1 213.40	-----	-----	2.2
SJ1-44SWSF4Y	1 229.55	-----	-----	2.2
SJ1-45SWSF4Y	1 242.77	-----	-----	2.2
SJ1-46SWSF4Y	1 255.63	-----	-----	2.2
SJ1-47SWSF4Y	1 268.48	-----	-----	2.2
SJ1-48SWSF4Y	1 281.33	-----	-----	2.2
SJ1-49SWSF4Y	1 294.19	-----	-----	2.2
SJ1-50SWSF4Y	1 307.39	-----	-----	2.2

Многоступенчатые погружные насосы из нержавеющей стали SJ 3

4 дюймовый двигатель		6 дюймовый двигатель		Мощность (кВт)
Артикул	Цена розница (USD) с НДС	Артикул	Цена розница (USD) с НДС	
SJ3-1SWSF4Y	451.85	-----	-----	0.37
SJ3-2SWSF4Y	465.14	-----	-----	0.37
SJ3-3SWSF4Y	478.43	-----	-----	0.37
SJ3-4SWSF4Y	491.72	-----	-----	0.37
SJ3-5SWSF4Y	505.01	-----	-----	0.37
SJ3-6SWSF4Y	518.30	-----	-----	0.37
SJ3-7SWSF4Y	531.94	-----	-----	0.55
SJ3-8SWSF4Y	545.24	-----	-----	0.55
SJ3-9SWSF4Y	558.52	-----	-----	0.55
SJ3-10SWSF4Y	609.21	-----	-----	0.75
SJ3-11SWSF4Y	622.50	-----	-----	0.75
SJ3-12SWSF4Y	636.15	-----	-----	0.75
SJ3-13SWSF4Y	681.24	-----	-----	1.1
SJ3-14SWSF4Y	694.53	-----	-----	1.1
SJ3-15SWSF4Y	707.83	-----	-----	1.1
SJ3-16SWSF4Y	721.47	-----	-----	1.1
SJ3-17SWSF4Y	734.76	-----	-----	1.1
SJ3-18SWSF4Y	748.05	-----	-----	1.1
SJ3-19SWSF4Y	806.33	-----	-----	1.5
SJ3-20SWSF4Y	819.62	-----	-----	1.5
SJ3-21SWSF4Y	833.27	-----	-----	1.5
SJ3-22SWSF4Y	846.55	-----	-----	1.5
SJ3-23SWSF4Y	959.49	-----	-----	2.2
SJ3-24SWSF4Y	972.78	-----	-----	2.2
SJ3-25SWSF4Y	986.07	-----	-----	2.2
SJ3-26SWSF4Y	999.70	-----	-----	2.2
SJ3-27SWSF4Y	1 013.00	-----	-----	2.2
SJ3-28SWSF4Y	1 026.29	-----	-----	2.2
SJ3-29SWSF4Y	1 039.58	-----	-----	2.2
SJ3-30SWSF4Y	1 052.87	-----	-----	2.2
SJ3-31SWSF4Y	1 066.52	-----	-----	2.2
SJ3-32SWSF4Y	1 079.80	-----	-----	2.2
SJ3-33SWSF4Y	1 341.06	-----	-----	3
SJ3-34SWSF4Y	1 354.35	-----	-----	3
SJ3-35SWSF4Y	1 367.64	-----	-----	3
SJ3-36SWSF4Y	1 381.29	-----	-----	3
SJ3-37SWSF4Y	1 394.57	-----	-----	3
SJ3-38SWSF4Y	1 407.87	-----	-----	3
SJ3-39SWSF4Y	1 421.16	-----	-----	3
SJ3-40SWSF4Y	1 434.79	-----	-----	3
SJ3-41SWSF4Y	1 448.08	-----	-----	3
SJ3-42SWSF4Y	1 461.38	-----	-----	3
SJ3-43SWSF4Y	1 474.66	-----	-----	3

Многоступенчатые погружные насосы из нержавеющей стали SJ 5

4 дюймовый двигатель		6 дюймовый двигатель		Мощность (кВт)
Артикул	Цена розница (USD) с НДС	Артикул	Цена розница (USD) с НДС	
SJ5-1SWSF4Y	454.95	----	-----	0.37
SJ5-2SWSF4Y	468.28	----	-----	0.37
SJ5-3SWSF4Y	481.62	----	-----	0.37
SJ5-4SWSF4Y	494.96	----	-----	0.37
SJ5-5SWSF4Y	508.30	----	-----	0.55
SJ5-6SWSF4Y	521.63	----	-----	0.55
SJ5-7SWSF4Y	572.72	----	-----	0.75
SJ5-8SWSF4Y	586.06	----	-----	0.75
SJ5-9SWSF4Y	630.52	----	-----	1.1
SJ5-10SWSF4Y	643.85	----	-----	1.1
SJ5-11SWSF4Y	657.20	----	-----	1.1
SJ5-12SWSF4Y	670.88	----	-----	1.1
SJ5-13SWSF4Y	728.53	----	-----	1.5
SJ5-14SWSF4Y	741.88	----	-----	1.5
SJ5-15SWSF4Y	755.21	----	-----	1.5
SJ5-16SWSF4Y	768.91	----	-----	1.5
SJ5-17SWSF4Y	782.24	----	-----	1.5
SJ5-18SWSF4Y	895.22	----	-----	2.2
SJ5-19SWSF4Y	909.92	----	-----	2.2
SJ5-20SWSF4Y	923.25	----	-----	2.2
SJ5-21SWSF4Y	936.95	----	-----	2.2
SJ5-22SWSF4Y	950.29	----	-----	2.2
SJ5-23SWSF4Y	963.63	----	-----	2.2
SJ5-24SWSF4Y	976.97	----	-----	2.2
SJ5-25SWSF4Y	990.30	----	-----	2.2
SJ5-26SWSF4Y	1 246.94	----	-----	3
SJ5-27SWSF4Y	1 260.28	----	-----	3
SJ5-28SWSF4Y	1 273.61	----	-----	3
SJ5-29SWSF4Y	1 286.94	----	-----	3
SJ5-30SWSF4Y	1 300.29	----	-----	3
SJ5-31SWSF4Y	1 313.98	----	-----	3
SJ5-32SWSF4Y	1 327.32	----	-----	3
SJ5-33SWSF4Y	1 345.68	----	-----	3
SJ5-34SWSF4Y	1 446.23	----	-----	4
SJ5-35SWSF4Y	1 459.56	----	-----	4
SJ5-36SWSF4Y	1 473.26	----	-----	4
SJ5-37SWSF4Y	1 486.59	----	-----	4
SJ5-38SWSF4Y	1 499.93	----	-----	4
SJ5-39SWSF4Y	1 513.26	----	-----	4
SJ5-40SWSF4Y	1 526.96	----	-----	4
SJ5-41SWSF4Y	1 540.29	----	-----	4
SJ5-42SWSF4Y	1 553.63	----	-----	4
SJ5-43SWSF4Y	1 566.96	----	-----	4

Многоступенчатые погружные насосы из нержавеющей стали SJ 8

4 дюймовый двигатель		6 дюймовый двигатель		Мощность (кВт)
Артикул	Цена розница (USD) с НДС	Артикул	Цена розница (USD) с НДС	
SJ8-1SWSF4Y	504.58	----	-----	0.37
SJ8-2SWSF4Y	530.84	----	-----	0.37
SJ8-3SWSF4Y	556.75	----	-----	0.55
SJ8-4SWSF4Y	620.40	----	-----	0.75
SJ8-5SWSF4Y	646.31	----	-----	0.75
SJ8-6SWSF4Y	703.34	----	-----	1.1
SJ8-7SWSF4Y	729.61	----	-----	1.1
SJ8-8SWSF4Y	799.13	----	-----	1.5
SJ8-9SWSF4Y	825.40	----	-----	1.5
SJ8-10SWSF4Y	851.31	----	-----	1.5
SJ8-11SWSF4Y	976.86	----	-----	2.2
SJ8-12SWSF4Y	1 003.11	----	-----	2.2
SJ8-13SWSF4Y	1 031.07	----	-----	2.2
SJ8-14SWSF4Y	1 057.32	----	-----	2.2
SJ8-15SWSF4Y	1 083.23	----	-----	2.2
SJ8-16SWSF4Y	1 352.44	----	-----	3
SJ8-17SWSF4Y	1 378.35	----	-----	3
SJ8-18SWSF4Y	1 404.25	----	-----	3
SJ8-19SWSF4Y	1 517.73	----	-----	4
SJ8-20SWSF4Y	1 543.63	----	-----	4
SJ8-21SWSF4Y	1 569.90	----	-----	4
SJ8-22SWSF4Y	1 598.68	----	-----	4
SJ8-23SWSF4Y	1 624.93	----	-----	4
SJ8-24SWSF4Y	1 650.84	----	-----	4
SJ8-25SWSF4Y	1 676.75	----	-----	4

SJ8-26SWSF4Y	1 883.67	-----	-----	5.5
SJ8-27SWSF4Y	1 909.57	-----	-----	5.5
SJ8-28SWSF4Y	1 935.83	-----	-----	5.5
SJ8-29SWSF4Y	1 961.74	-----	-----	5.5
SJ8-30SWSF4Y	1 987.65	-----	-----	5.5
SJ8-31SWSF4Y	2 018.62	-----	-----	5.5
SJ8-32SWSF4Y	2 044.52	-----	-----	5.5
SJ8-33SWSF4Y	2 070.78	-----	-----	5.5
SJ8-34SWSF4Y	2 096.69	-----	-----	5.5
SJ8-35SWSF4Y	2 122.95	-----	-----	5.5
SJ8-36SWSF4Y	2 148.85	-----	-----	5.5
SJ8-37SWSF4Y	2 174.76	-----	-----	5.5
SJ8-38SWSF4Y	2 400.39	-----	-----	7.5
SJ8-39SWSF4Y	2 426.29	-----	-----	7.5
SJ8-40SWSF4Y	2 452.55	-----	-----	7.5
SJ8-41SWSF4Y	2 478.46	-----	-----	7.5
SJ8-42SWSF4Y	2 504.86	-----	-----	7.5
SJ8-43SWSF4Y	2 530.76	-----	-----	7.5
SJ8-44SWSF4Y	2 556.67	-----	-----	7.5
SJ8-45SWSF4Y	2 582.79	-----	-----	7.5
SJ8-46SWSF4Y	2 608.70	-----	-----	7.5
SJ8-47SWSF4Y	2 634.96	-----	-----	7.5
SJ8-48SWSF4Y	2 660.86	-----	-----	7.5
SJ8-49SWSF4Y	2 686.77	-----	-----	7.5
SJ8-50SWSF4Y	2 713.04	-----	-----	7.5

Многоступенчатые погружные насосы из нержавеющей стали SJ 12

4 дюймовый двигатель		6 дюймовый двигатель		Мощность (кВт)
Артикул	Цена розница (USD) с НДС	Артикул	Цена розница (USD) с НДС	
SJ12-1SWSF4Y	531.13	-----	-----	0.37
SJ12-2SWSF4Y	575.63	-----	-----	0.55
SJ12-3SWSF4Y	688.26	-----	-----	1.1
SJ12-4SWSF4Y	732.76	-----	-----	1.1
SJ12-5SWSF4Y	820.89	-----	-----	1.5
SJ12-6SWSF4Y	964.64	-----	-----	2.2
SJ12-7SWSF4Y	1 009.14	-----	-----	2.2
SJ12-8SWSF4Y	1 296.59	-----	-----	3
SJ12-9SWSF4Y	1 340.69	-----	-----	3
SJ12-10SWSF4Y	1 385.20	-----	-----	3
SJ12-11SWSF4Y	1 516.92	-----	-----	4
SJ12-12SWSF4Y	1 561.02	-----	-----	4
SJ12-13SWSF4Y	1 607.82	-----	-----	4
SJ12-14SWSF4Y	1 833.00	-----	-----	5.5
SJ12-15SWSF4Y	1 877.11	-----	-----	5.5
SJ12-16SWSF4Y	1 921.60	-----	-----	5.5
SJ12-17SWSF4Y	1 966.10	-----	-----	5.5
SJ12-18SWSF4Y	2 010.44	-----	-----	5.5
SJ12-19SWSF4Y	2 254.07	-----	-----	7.5
SJ12-20SWSF4Y	2 298.58	-----	-----	7.5
SJ12-21SWSF4Y	2 342.68	-----	-----	7.5
SJ12-22SWSF4Y	2 390.43	-----	-----	7.5
SJ12-23SWSF4Y	2 434.92	-----	-----	7.5
SJ12-24SWSF4Y	2 479.02	-----	-----	7.5
SJ12-25SWSF4Y	2 523.53	-----	-----	7.5

Многоступенчатые погружные насосы из нержавеющей стали SJ 17

4 дюймовый двигатель		6 дюймовый двигатель		Мощность (кВт)
Артикул	Цена розница (USD) с НДС	Артикул	Цена розница (USD) с НДС	
SJ17-1SWSF4Y	670.15	-----	-----	0.55
SJ17-2SWSF4Y	807.38	-----	-----	1.1
SJ17-3SWSF4Y	1 019.88	-----	-----	2.2
SJ17-4SWSF4Y	1 089.11	-----	-----	2.2
SJ17-5SWSF4Y	1 400.78	-----	-----	3
SJ17-6SWSF4Y	1 561.60	SJ17-6SWSP6Y	2 421.43	4
SJ17-7SWSF4Y	1 630.81	SJ17-7SWSP6Y	2 494.98	4
SJ17-8SWSF4Y	1 880.21	SJ17-8SWSP6Y	2 613.24	5.5
SJ17-9SWSF4Y	1 949.44	SJ17-9SWSP6Y	2 683.13	5.5
SJ17-10SWSF4Y	2 018.17	SJ17-10SWSP6Y	2 752.51	5.5
SJ17-11SWSF4Y	2 286.74	SJ17-11SWSP6Y	2 978.12	7.5
SJ17-12SWSF4Y	2 355.97	SJ17-12SWSP6Y	3 048.00	7.5
SJ17-13SWSF4Y	2 424.69	SJ17-13SWSP6Y	3 117.38	7.5
-----	-----	SJ17-14SWSP6Y	3 377.64	9.2
-----	-----	SJ17-15SWSP6Y	3 447.02	9.2
-----	-----	SJ17-16SWSP6Y	3 516.90	9.2
-----	-----	SJ17-17SWSP6Y	3 586.79	9.2

----	----	SJ17-18SWSP6Y	3 874.19	11
----	----	SJ17-19SWSP6Y	3 944.07	11
----	----	SJ17-20SWSP6Y	4 013.95	11
----	----	SJ17-21SWSP6Y	4 242.54	13
----	----	SJ17-22SWSP6Y	4 312.43	13
----	----	SJ17-23SWSP6Y	4 381.81	13
----	----	SJ17-24SWSP6Y	4 451.69	13
----	----	SJ17-25SWSP6Y	4 770.75	15
----	----	SJ17-26SWSP6Y	4 840.15	15

Многоступенчатые погружные насосы из нержавеющей стали SJ 30

4 дюймовый двигатель		6 дюймовый двигатель		Мощность (кВт)
Артикул	Цена розница (USD) с НДС	Артикул	Цена розница (USD) с НДС	
SJ30-1SWSF4Y	779.46	----	-----	1.1
SJ30-2SWSF4Y	1 009.82	----	-----	2.2
SJ30-3SWSF4Y	1 349.28	----	-----	3
SJ30-4SWSF4Y	1 533.02	----	-----	4
SJ30-5SWSF4Y	1 810.20	SJ30-5SWSP6Y	2 543.14	5.5
SJ30-6SWSF4Y	1 911.10	SJ30-6SWSP6Y	2 643.22	5.5
SJ30-7SWSF4Y	2 206.97	SJ30-7SWSP6Y	2 899.04	7.5
SJ30-8SWSF4Y	2 303.49	SJ30-8SWSP6Y	2 999.13	7.5
----	-----	SJ30-9SWSP6Y	3 286.11	9.2
----	-----	SJ30-10SWSP6Y	3 386.20	9.2
----	-----	SJ30-11SWSP6Y	3 486.29	9.2
----	-----	SJ30-12SWSP6Y	3 804.39	11
----	-----	SJ30-13SWSP6Y	3 904.46	11
----	-----	SJ30-14SWSP6Y	4 163.77	13
----	-----	SJ30-15SWSP6Y	4 263.86	13
----	-----	SJ30-16SWSP6Y	4 613.13	15
----	-----	SJ30-17SWSP6Y	4 713.20	15
----	-----	SJ30-18SWSP6Y	5 062.47	18.5
----	-----	SJ30-19SWSP6Y	5 162.56	18.5
----	-----	SJ30-20SWSP6Y	5 262.64	18.5
----	-----	SJ30-21SWSP6Y	5 366.22	18.5
----	-----	SJ30-22SWSP6Y	5 840.04	22
----	-----	SJ30-23SWSP6Y	5 939.64	22
----	-----	SJ30-24SWSP6Y	6 039.72	22
----	-----	SJ30-25SWSP6Y	6 139.81	22

Многоступенчатые погружные насосы из нержавеющей стали SJ 42

4 дюймовый двигатель		6 дюймовый двигатель		Мощность (кВт)
Артикул	Цена розница (USD) с НДС	Артикул	Цена розница (USD) с НДС	
SJ42-1SWSF4Y	996.85	----	-----	2.2
SJ42-2SWSF4Y	1 361.03	----	-----	3
SJ42-3SWSF4Y	1 759.26	SJ42-3SWSP6Y	2 487.60	5.5
SJ42-4SWSF4Y	2 088.96	SJ42-4SWSP6Y	2 775.28	7.5
SJ42-5SWSF4Y	2 219.31	SJ42-5SWSP6Y	2 907.21	7.5
----	-----	SJ42-6SWSP6Y	3 233.82	9.2
----	-----	SJ42-7SWSP6Y	3 583.77	11
----	-----	SJ42-8SWSP6Y	3 871.43	13
----	-----	SJ42-9SWSP6Y	4 253.15	15
----	-----	SJ42-10SWSP6Y	4 385.09	15
----	-----	SJ42-11SWSP6Y	4 766.19	18.5
----	-----	SJ42-12SWSP6Y	4 898.13	18.5
----	-----	SJ42-13SWSP6Y	5 403.81	22
----	-----	SJ42-14SWSP6Y	5 537.82	22
----	-----	SJ42-15SWSP6Y	5 669.76	22
----	-----	SJ42-16SWSP6Y	6 283.54	25
----	-----	SJ42-17SWSP6Y	6 416.09	25
----	-----	SJ42-18SWSP6Y	6 813.69	30
----	-----	SJ42-19SWSP6Y	6 945.63	30
----	-----	SJ42-20SWSP6Y	7 077.56	30
----	-----	SJ42-21SWSP6Y	8 014.19	37
----	-----	SJ42-22SWSP6Y	8 162.16	37

Многоступенчатые погружные насосы из нержавеющей стали SJ 60

4 дюймовый двигатель		6 дюймовый двигатель		Мощность (кВт)
Артикул	Цена розница (USD) с НДС	Артикул	Цена розница (USD) с НДС	
SJ60-1SWSF4Y	1 023.32	----	-----	2.2
SJ60-2-2SWSF4Y	1 398.00	----	-----	3
SJ60-2SWSF4Y	1 485.21	----	-----	4
SJ60-3-2SWSF4Y	1 807.43	SJ60-3-2SWSP6Y	2 535.95	5.5
SJ60-3SWSF4Y	1 807.43	SJ60-3SWSP6Y	2 535.95	5.5
SJ60-4SWSF4Y	2 148.33	SJ60-4SWSP6Y	2 834.84	7.5
----	-----	SJ60-5SWSP6Y	3 164.86	9.2

----	----	SJ60-6SWSP6Y	3 534.41	11
----	----	SJ60-7SWSP6Y	3 833.27	13
----	----	SJ60-8-2SWSP6Y	3 976.41	13
----	----	SJ60-8SWSP6Y	4 225.59	15
----	----	SJ60-9-2SWSP6Y	4 369.38	15
----	----	SJ60-9SWSP6Y	4 618.56	18.5
----	----	SJ60-10SWSP6Y	4 761.70	18.5
----	----	SJ60-11SWSP6Y	5 278.59	22
----	----	SJ60-12SWSP6Y	5 421.73	22
----	----	SJ60-13SWSP6Y	5 567.10	22
----	----	SJ60-14SWSP6Y	6 192.10	25
----	----	SJ60-15SWSP6Y	6 335.25	25
----	----	SJ60-16SWSP6Y	6 744.04	30
----	----	SJ60-17SWSP6Y	6 887.84	30
----	----	SJ60-18SWSP6Y	7 030.98	30
----	----	SJ60-19SWSP6Y	7 970.32	37
----	----	SJ60-20SWSP6Y	8 130.70	37
----	----	SJ60-21SWSP6Y	8 291.11	37

Многоступенчатые погружные насосы из нержавеющей стали SJ 75

6 дюймовый двигатель		8 дюймовый двигатель		Мощность (кВт)
Артикул	Цена розница (USD) с НДС	Артикул	Цена розница (USD) с НДС	
SJ75-1SWSP6Y	2 917.58	----	-----	4
SJ75-2SWSP6Y	2 959.19	SJ75-2SWSP8S	4 165.91	7.5
SJ75-3SWSP6Y	3 853.20	SJ75-3SWSP8S	4 602.49	11
SJ75-4SWSP6Y	4 173.27	SJ75-4SWSP8S	4 872.29	15
SJ75-5SWSP6Y	4 386.65	SJ75-5SWSP8S	5 153.12	18.5
SJ75-6SWSP6Y	4 853.89	SJ75-6SWSP8S	5 411.88	22
SJ75-7SWSP6Y	6 172.22	SJ75-7SWSP8S	6 789.46	30
SJ75-8SWSP6Y	6 172.22	SJ75-8SWSP8S	6 789.46	30
SJ75-9SWSP6Y	7 197.44	SJ75-9SWSP8S	7 917.19	37
SJ75-10SWSP6Y	7 197.44	SJ75-10SWSP8S	7 917.19	37
----	-----	SJ75-11SWSP8S	7 947.97	45
----	-----	SJ75-12SWSP8S	7 947.97	45
----	-----	SJ75-13SWSP8S	9 170.65	55
----	-----	SJ75-14SWSP8S	9 170.65	55
----	-----	SJ75-15SWSP8S	9 170.65	55
----	-----	SJ75-16SWSP8S	11 007.72	63
----	-----	SJ75-17SWSP8S	11 007.72	63
----	-----	SJ75-18SWSP8S	13 494.75	75
----	-----	SJ75-19SWSP8S	13 494.75	75
----	-----	SJ75-20SWSP8S	13 494.75	75

Многоступенчатые погружные насосы из нержавеющей стали SJ 95

6 дюймовый двигатель		8 дюймовый двигатель		Мощность (кВт)
Артикул	Цена розница (USD) с НДС	Артикул	Цена розница (USD) с НДС	
SJ95-2SWSP6Y	3 610.37	SJ95-2SWSP8S	4 386.65	9.2
SJ95-3SWSP6Y	4 173.27	SJ95-3SWSP8S	4 872.29	13
SJ95-4SWSP6Y	4 386.65	SJ95-4SWSP8S	5 153.12	18.5
SJ95-5SWSP6Y	4 853.89	SJ95-5SWSP8S	5 411.88	22
SJ95-6SWSP6Y	5 554.14	SJ95-6SWSP8S	5 897.52	25
SJ95-7SWSP6Y	6 172.22	SJ95-7SWSP8S	6 789.46	30
SJ95-8SWSP6Y	7 197.44	SJ95-8SWSP8S	7 917.19	37
SJ95-9SWSP6Y	7 197.44	SJ95-9SWSP8S	7 917.19	37
----	-----	SJ95-10SWSP8S	7 947.97	45
----	-----	SJ95-11SWSP8S	7 947.97	45
----	-----	SJ95-12SWSP8S	9 170.65	55
----	-----	SJ95-13SWSP8S	9 170.65	55
----	-----	SJ95-14SWSP8S	9 170.65	55
----	-----	SJ95-15SWSP8S	11 007.72	63
----	-----	SJ95-16SWSP8S	11 007.72	63
----	-----	SJ95-17SWSP8S	13 494.75	75
----	-----	SJ95-18SWSP8S	13 494.75	75

Многоступенчатые погружные насосы из нержавеющей стали SJ 120

6 дюймовый двигатель		8 дюймовый двигатель		Мощность (кВт)
Артикул	Цена розница (USD) с НДС	Артикул	Цена розница (USD) с НДС	
SJ 120-1SWSP6Y	4 764.06	SJ 120-1SWSP8S	5 592.86	11
SJ 120-2-2SWSP6Y	5 678.89	SJ 120-2-2SWSP8S	6 578.05	15
SJ 120-2-1SWSP6Y	6 121.85	SJ 120-2-1SWSP8S	6 791.23	18.5
SJ 120-2SWSP6Y	6 334.82	SJ 120-2SWSP8S	7 071.03	22
SJ 120-3-2SWSP6Y	7 209.64	SJ 120-3-2SWSP8S	7 970.45	25
SJ 120-3-1SWSP6Y	8 206.81	SJ 120-3-1SWSP8S	8 242.99	30
SJ 120-3SWSP6Y	8 212.11	SJ 120-3SWSP8S	8 242.99	30
SJ 120-4-2SWSP6Y	9 228.69	SJ 120-4-2SWSP8S	9 595.24	37

SJ 120-4-1SWSP6Y	9 228.69	SJ 120-4-1SWSP8S	9 595.24	37
SJ 120-4SWSP6Y	9 232.83	SJ 120-4SWSP8S	9 595.24	37
-----	-----	SJ 120-5-2SWSP8S	10 739.23	45
-----	-----	SJ 120-5-1SWSP8S	10 739.23	45
-----	-----	SJ 120-5SWSP8S	11 574.44	55
-----	-----	SJ 120-6-2SWSP8S	12 235.79	55
-----	-----	SJ 120-6-1SWSP8S	12 235.79	55
-----	-----	SJ 120-6SWSP8S	13 627.13	63
-----	-----	SJ 120-7-2SWSP8S	14 288.49	63
-----	-----	SJ 120-7-1SWSP8S	14 288.49	63
-----	-----	SJ 120-7SWSP8S	16 229.08	75
-----	-----	SJ 120-8-2SWSP8S	16 890.43	75
-----	-----	SJ 120-8-1SWSP8S	16 890.43	75
-----	-----	SJ 120-8SWSP8S	16 890.43	75
-----	-----	SJ 120-9-2SWSP8S	18 352.53	90
-----	-----	SJ 120-9-1SWSP8S	18 352.53	90
-----	-----	SJ 120-9SWSP8S	18 352.53	90
-----	-----	SJ 120-10-2SWSP8S	19 013.88	90
-----	-----	SJ 120-10-1SWSP8S	19 013.88	90
-----	-----	SJ 120-10SWSP8S	24 201.07	110
-----	-----	SJ 120-11-2SWSP8S	24 862.42	110
-----	-----	SJ 120-11-1SWSP8S	24 862.42	110
-----	-----	SJ 120-11SWSP8S	24 862.42	110

Многоступенчатые погружные насосы из нержавеющей стали SJ 150

6 дюймовый двигатель		8 дюймовый двигатель		Мощность (кВт)
Артикул	Цена розница (USD) с НДС	Артикул	Цена розница (USD) с НДС	
SJ 150-1-1SWSP6Y	4 648.19	SJ 150-1-1SWSP8S	5 521.75	9.2
SJ 150-1SWSP6Y	4 948.79	SJ 150-1SWSP8S	5 909.87	13
SJ 150-2-2SWSP6Y	6 121.89	SJ 150-2-2SWSP8S	6 785.10	18.5
SJ 150-2-1SWSP6Y	6 331.87	SJ 150-2-1SWSP8S	7 064.63	22
SJ 150-2SWSP6Y	6 554.86	SJ 150-2SWSP8S	7 302.47	25
SJ 150-3-2SWSP6Y	8 206.81	SJ 150-3-2SWSP8S	8 235.47	30
SJ 150-3-1SWSP6Y	8 573.33	SJ 150-3-1SWSP8S	8 925.32	37
SJ 150-3SWSP6Y	8 573.33	SJ 150-3SWSP8S	8 925.32	37
-----	-----	SJ 150-4-2SWSP8S	10 068.24	45
-----	-----	SJ 150-4-1SWSP8S	10 068.24	45
-----	-----	SJ 150-4SWSP8S	10 902.63	55
-----	-----	SJ 150-5-2SWSP8S	11 563.34	55
-----	-----	SJ 150-5-1SWSP8S	11 563.34	55
-----	-----	SJ 150-5SWSP8S	12 876.86	63
-----	-----	SJ 150-6-2SWSP8S	13 537.56	63
-----	-----	SJ 150-6-1SWSP8S	15 552.80	75
-----	-----	SJ 150-6SWSP8S	15 552.80	75
-----	-----	SJ 150-7-2SWSP8S	16 213.52	75
-----	-----	SJ 150-7-1SWSP8S	17 013.50	90
-----	-----	SJ 150-7SWSP8S	17 013.50	90
-----	-----	SJ 150-8-2SWSP8S	17 674.22	90
-----	-----	SJ 150-8-1SWSP8S	22 856.43	110
-----	-----	SJ 150-8SWSP8S	22 856.43	110
-----	-----	SJ 150-9-2SWSP8S	23 517.54	110
-----	-----	SJ 150-9-1SWSP8S	23 517.54	110
-----	-----	SJ 150-9SWSP8S	23 517.54	110

Многоступенчатые погружные насосы из нержавеющей стали SJ 200

10 дюймовый двигатель		Мощность (кВт)
Артикул	Цена розница (USD) с НДС	
SJ200-1SWSP10S	11 256.57	30
SJ200-2-2BSWSP10S	12 757.93	37
SJ200-2-2ASWSP10S	13 143.25	45
SJ200-2-ASWSP10S	13 560.35	55
SJ200-2SWSP10S	13 560.35	55
SJ200-3-2BSWSP10S	18 387.37	75
SJ200-3-A-BSWSP10S	18 387.37	75
SJ200-3-2ASWSP10S	18 387.37	75
SJ200-3-BSWSP10S	18 387.37	75
SJ200-3-ASWSP10S	18 387.37	75
SJ200-3SWSP10S	19 657.53	90
SJ200-4-2BSWSP10S	20 826.47	90
SJ200-4-2ASWSP10S	22 733.76	110
SJ200-4-ASWSP10S	22 733.76	110
SJ200-4SWSP10S	22 733.76	110



СЕЗОННАЯ АКЦИЯ

SM многоступенчатые погружные насосы из нержавеющей стали (пласт.раб.колесо)

1. Все агрегаты электронасосные поставляются с кабелем
2. Однофазные электродвигатели агрегатов электронасосных комплектуются
3. Возможна комплектация охлаждающим кожухом из ПВХ. Стоимость

ТОЛЬКО ДЛЯ ВЕРТИКАЛЬНОЙ УСТАНОВКИ!!! Горизонтальный монтаж категорически запрещен!

**обновление
25.04.2022**

Модель/Артикул	Цена розница (USD) с НДС	Мощность, кВт	Модель/Артикул	Цена розница (USD) с НДС
1ф, 220В			3ф., 380В	
SM(A)1.8-11 D	183.37	0.25		
SM(A)1.8-15 D	204.11	0.37		
SM(A)1.8-20D	235.76	0.55		
SM(A)1.8-27 D	278.33	0.75		
SM(A)1.8-39 D	349.27	1.1		
SM(A)2.5-8 D	177.91	0.25		
SM(A)2.5-11 D	193.19	0.37		
SM(A)2.5-16 D	227.03	0.55		
SM(A)2.5-21 D	263.05	0.75		
SM(A)2.5-30 D	325.26	1.1		
SM(B)2-9 D	230.30	0.37	SM(B)2-9 S	225.94
SM(B)2-13 D	259.77	0.55	SM(B)2-13 S	255.41
SM(B)2-16 D	288.15	0.75	SM(B)2-16 S	282.69
SM(B)2-18 D	305.61	0.95	SM(B)2-18 S	300.16
SM(B)2-22 D	350.36	1.1	SM(B)2-22 S	342.72
SM(B)2-28 D	400.57	1.5	SM(B)2-28 S	392.93
SM(B)3-8 D	230.30	0.37	SM(B)3-8 S	225.94
SM(B)3-11 D	265.23	0.55	SM(B)3-11 S	259.77

SM(B)3-13 D	284.87	0.75	SM(B)3-13 S	279.42
SM(B)3-15 D	302.34	0.95	SM(B)3-15 S	295.79
SM(B)3-19 D	342.72	1.1	SM(B)3-19 S	335.08
SM(B)3-23 D	384.20	1.5	SM(B)3-23 S	363.46
SM(B1)2-9 D	189.92	0.37	SM(B1)2-9 S	205.20
SM(B1)2-13 D	216.11	0.55	SM(B1)2-13 S	232.48
SM(B1)2-16 D	245.58	0.75	SM(B1)2-16 S	264.14
SM(B1)2-18 D	260.86	0.95	SM(B1)2-18 S	282.69
SM(B1)2-22 D	297.97	1.1	SM(B1)2-22 S	321.99
SM(B1)2-28 D	348.18	1.5	SM(B1)2-28 S	367.83
SM(B1)3-8 D	191.01	0.37	SM(B1)3-8 S	206.29
SM(B1)3-11 D	219.39	0.55	SM(B1)3-11 S	235.76
SM(B1)3-13 D	241.22	0.75	SM(B1)3-13 S	259.77
SM(B1)3-15 D	251.04	0.95	SM(B1)3-15 S	271.78
SM(B1)3-19 D	291.42	1.1	SM(B1)3-19 S	314.34
SM(B1)3-23 D	340.54	1.5	SM(B1)3-23 S	360.19
SM(C)2-8 D	224.84	0.37	SM(C)2-8 S	204.11
SM(C)2-11 D	252.13	0.55	SM(C)2-11 S	231.39
SM(C)2-14 D	291.42	0.75	SM(C)2-14 S	270.69
SM(C)2-19 D	337.27	1.1	SM(C)2-19 S	314.34
SM(C)2-25 D	398.39	1.5	SM(C)2-25 S	374.38
SM(C)2-38 D	505.35	2.2	SM(C)2-38 S	484.61
		3	SM(C)2-52 S	744.39
		4	SM(C)2-65 S	849.17
SM(C)3-6 D	208.47	0.37	SM(C)3-6 S	220.48
SM(C)3-9 D	245.58	0.55	SM(C)3-9 S	241.22
SM(C)3-11 D	276.14	0.75	SM(C)3-11 S	270.69
SM(C)3-15 D	325.26	1.1	SM(C)3-15 S	319.80
SM(C)3-20 D	373.28	1.5	SM(C)3-20 S	362.37
SM(C)3-27 D	435.50	2.2	SM(C)3-27 S	459.51
		3	SM(C)3-40 S	554.47
		4	SM(C)3-50 S	803.33
		5.5	SM(C)3-62 S	1 062.01
SM(C)4-7 D	223.75	0.55	SM(C)4-7 S	220.48
SM(C)4-9 D	269.59	0.75	SM(C)4-9 S	247.76
SM(C)4-12 D	318.71	1.1	SM(C)4-12 S	292.52
SM(C)4-16 D	361.28	1.5	SM(C)4-16 S	335.08
SM(C)4-22 D	431.13	2.2	SM(C)4-22 S	402.75
		3	SM(C)4-32 S	528.27
		4	SM(C)4-40 S	693.09
		5.5	SM(C)4-50 S	1 072.92
		7.5	SM(C)4-62 S	1 195.17
SM(C)6-6 D	230.30	0.55	SM(C)6-6 S	227.03
SM(C)6-8 D	276.14	0.75	SM(C)6-8 S	253.22
SM(C)6-11 D	318.71	1.1	SM(C)6-11 S	292.52

SM(C)6-14 D	368.92	1.5	SM(C)6-14 S	342.72
SM(C)6-20 D	444.23	2.2	SM(C)6-20 S	415.85
		3	SM(C)6-28 S	549.01
		4	SM(C)6-36 S	612.32
		5.5	SM(C)6-46 S	946.31
		7.5	SM(C)6-52 S	1 110.03
SM(C)8-5 D	227.03	0.55	SM(C)8-5 S	223.75
SM(C)8-6 D	268.50	0.75	SM(C)8-6 S	246.67
SM(C)8-8 D	308.89	1.1	SM(C)8-8 S	282.69
SM(C)8-11 D	355.82	1.5	SM(C)8-11 S	329.63
SM(C)8-15 D	419.13	2.2	SM(C)8-15 S	389.66
		3	SM(C)8-20 S	505.35
		4	SM(C)8-28 S	601.40
		5.5	SM(C)8-36 S	817.51
		7.5	SM(C)8-44 S	1 100.21
SM(C)10-5 D	247.76	0.75	SM(C)10-5 S	244.49
SM(C)10-6 D	304.52	1.1	SM(C)10-6 S	276.14
SM(C)10-9 D	344.91	1.5	SM(C)10-9 S	317.62
SM(C)10-13 D	411.49	2.2	SM(C)10-13 S	379.83
		3	SM(C)10-18 S	492.26
		4	SM(C)10-23 S	567.57
		5.5	SM(C)10-28 S	783.68
		7.5	SM(C)10-36 S	901.56
SM(C)16-5 D	416.94	1.1	SM(C)16-5 S	409.30
SM(C)16-7 D	454.05	1.5	SM(C)16-7 S	445.32
SM(C)16-10 D	491.16	2.2	SM(C)16-10 S	481.34
		3	SM(C)16-13 S	591.58
		4	SM(C)16-17 S	690.90
		5.5	SM(C)16-22 S	933.21
		7.5	SM(C)16-28 S	1 104.57
		2.2	SM(G)25-2 S	575.21
		3	SM(G)25-3 S	650.52
		4	SM(G)25-4 S	713.82
		5.5	SM(G)25-5 S	873.18
		7.5	SM(G)25-7 S	1 007.43
		9.2	SM(G)25-9 S	1 239.92
		11	SM(G)25-11 S	1 493.14
		13	SM(G)25-13 S	1 631.76
		15	SM(G)25-15 S	1 754.00
			SM(F1)12-24 S	1 295.91
			SM(F1)12-29 S	1 546.38

Сезонная акционная цена ведена на неограниченный срок, об окончании акции будет сообщено в новостной рассылке.

Погружные электронасосы WQ для отвода канализационных сточных вод

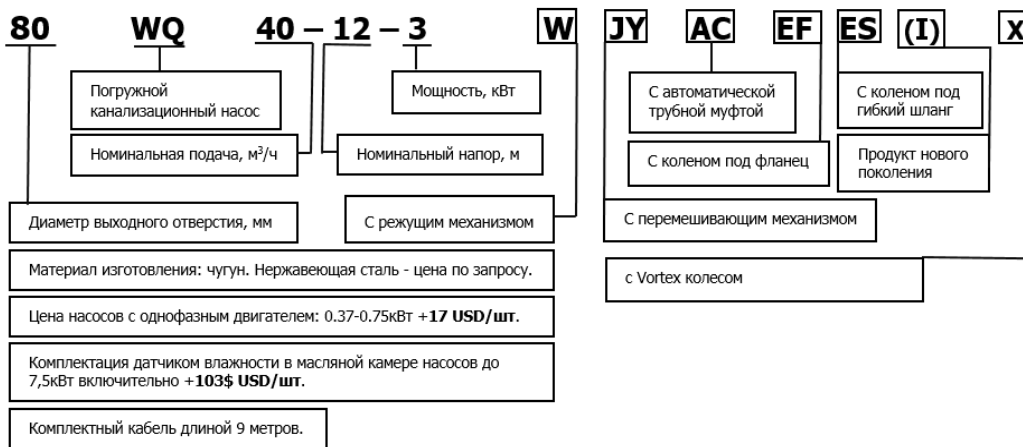

Комплектация насосов серии WQ ATM		
Модель ATM	Применяется для	Примечание
TOS-40~150 TO-150~500	Насосы WQ мощностью более 0.55 кВт (за исключением 4-х полюсных моделей DN100 мощностью 18.5-22 кВт и насосов серии WQ-H).	Стандартная автоматическая трубная муфта
TOS-80F TOS-100F	4-х полюсные насосы с напорным патрубком DN100 и мощностью 18.5-22 кВт (например, 100WQ100-39-22AC(I); насосы серии WQ-H.	Усиленная автоматическая трубная муфта

обновление
01.06.2022

Модель/арт. WQ с ATM	Скорость, об/мин	DN	Цена розница WQ, USD с НДС		
			с ATM	под гибкий шланг/ под ATM	колесо с фланцем
2-х полюсные					
40WQ12-10-0.75AC(I)	2850	40	787.71	485.33	522.18
40WQ8-15-1.1AC(I)	2850	40	853.78	551.40	586.97
40WQ15-8-1.1AC(I)	2850	40	853.78	551.40	586.97
40WQ15-13-1.1AC(I)	2850	40	853.78	551.40	586.97

40WQ12-18-1.5AC(I)	2880	40	952.88	650.50	687.34
50WQ10-7-0.55AC(I)	2850	50	848.69	496.77	539.96
50WQ12-10-0.75AC(I)	2850	50	848.69	496.77	539.96
50WQ8-15-1.1AC(I)	2850	50	903.33	551.40	594.59
50WQ10-13-1.1AC(I)	2850	50	903.33	551.40	594.59
50WQ15-8-1.1AC(I)	2850	50	903.33	551.40	594.59
50WQ15-13-1.1AC(I)	2850	50	903.33	551.40	594.59
50WQ10-15-1.5AC(I)	2880	50	1 002.42	650.50	694.96
50WQ10-18-1.5AC(I)	2880	50	1 002.42	650.50	694.96
50WQ12-12-1.5AC(I)	2880	50	1 002.42	650.50	694.96
50WQ15-10-1.5AC(I)	2880	50	1 002.42	650.50	694.96
50WQ15-15-1.5AC(I)	2880	50	1 002.42	650.50	694.96
50WQ9-22-2.2AC(I)	2880	50	1 109.15	757.22	802.96
50WQ15-18-2.2AC(I)	2880	50	1 109.15	757.22	802.96
50WQ15-20-2.2AC(I)	2880	50	1 109.15	757.22	802.96
50WQ20-15-2.2AC(I)	2880	50	1 109.15	757.22	802.96
50WQ25-10-2.2AC(I)	2880	50	1 109.15	757.22	802.96
50WQ15-25-3AC(I)	2840	50	1 184.11	832.18	877.92
50WQ15-27-3AC(I)	2840	50	1 184.11	832.18	877.92
50WQ25-20-3AC(I)	2840	50	1 184.11	832.18	877.92
50WQ15-32-4AC(I)	2840	50	1 509.35	1 157.43	1 200.62
50WQ15-40-5.5AC(I)	2940	50	1 694.85	1 342.92	1 387.39
50WQ20-30-5.5AC(I)	2940	50	1 694.85	1 342.92	1 387.39
50WQ25-25-5.5AC(I)	2940	50	1 694.85	1 342.92	1 387.39
50WQ20-40-7.5AC(I)	2940	50	2 206.86	1 854.93	1 899.40
50WQ25-35-7.5AC(I)	2940	50	2 206.86	1 854.93	1 899.40
65WQ15-10-1.1AC(I)	2850	65	1 030.38	551.40	608.57
65WQ25-10-1.5AC(I)	2850	65	1 142.18	663.20	721.64
65WQ25-14-2.2AC(I)	2880	65	1 236.20	757.22	815.66
65WQ35-7-2.2AC(I)	2880	65	1 236.20	757.22	815.66
65WQ25-15-3AC(I)	2840	65	1 311.16	832.18	890.62
65WQ25-18-3AC(I)	2840	65	1 311.16	832.18	890.62
65WQ37-13-3AC(I)	2840	65	1 311.16	832.18	890.62
65WQ40-10-3AC(I)	2840	65	1 311.16	832.18	890.62
65WQ20-25-4AC(I)	2840	65	1 636.40	1 157.43	1 215.87
65WQ20-27-4AC(I)	2840	65	1 636.40	1 157.43	1 215.87
65WQ25-31-5.5AC(I)	2940	65	1 821.90	1 342.92	1 401.36
65WQ30-25-5.5AC(I)	2940	65	1 821.90	1 342.92	1 401.36
65WQ20-60-11AC(I) Ductile iron	2930	50	3 652.69	3 173.71	3 232.15
65WQ40-50-11AC(I) Ductile iron	2930	65	3 652.69	3 173.71	3 232.15
65WQ30-60-15AC(I) Ductile iron	2930	65	4 096.09	3 617.11	3 711.13
65WQ50-55-15AC(I) Ductile iron	2930	65	4 096.09	3 617.11	3 711.13
80WQ40-8-2.2AC(I)	2880	80	1 422.96	775.01	849.96
80WQ40-10-2.2AC(I)	2880	80	1 422.96	775.01	849.96
80WQ45-9-2.2AC(I)	2880	80	1 422.96	775.01	849.96
80WQ35-13-3AC(I)	2840	80	1 490.30	842.34	917.30
80WQ40-15-4AC(I)	2840	80	1 829.52	1 181.57	1 256.52

80WQ40-22-5.5AC(I)	2940	80	2 041.69	1 393.74	1 468.70
80WQ40-30-7.5AC(I)	2940	80	2 621.04	1 973.09	2 048.05
80WQ50-25-7.5AC(I)	2940	80	2 621.04	1 973.09	2 048.05
80WQ48-38-11AC(I)	2930	80	3 566.29	2 918.34	2 993.30
100WQ50-7-2.2AC(I)	2880	100	1 641.49	775.01	883.00
100WQ60-9-3AC(I)	2840	100	1 732.96	866.48	974.47
100WQ50-12-4AC(I)	2840	100	2 048.05	1 181.57	1 290.83
100WQ65-15-5.5AC(I)	2940	100	2 299.61	1 433.12	1 541.12
100WQ65-18-5.5AC(I)	2940	100	2 299.61	1 433.12	1 541.12
100WQ70-14-5.5AC(I)	2940	100	2 299.61	1 433.12	1 541.12
100WQ45-22-7.5AC(I)	2940	100	2 857.35	1 990.87	2 098.87
100WQ65-20-7.5AC(I)	2940	100	2 857.35	1 990.87	2 098.87
100WQ80-15-7.5AC(I)	2940	100	2 857.35	1 990.87	2 098.87
100WQ100-15-7.5AC(I)	2940	100	2 857.35	1 990.87	2 098.87
100WQ80-25-11AC(I)	2940	100	4 172.32	3 305.84	3 413.83
100WQ100-30-15AC(I)	2940	100	4 752.94	3 886.46	3 986.83
150WQ100-7-5.5AC(I)	2940	150	3 087.32	1 519.52	1 732.96
150WQ100-10-5.5AC(I)	2940	150	3 087.32	1 519.52	1 732.96
150WQ100-17-7.5AC(I)	2940	150	3 594.24	2 026.45	2 239.89
150WQ150-10-7.5AC(I)	2940	150	3 594.24	2 026.45	2 239.89
150WQ120-25-15AC(I)	2930	150	5 585.12	4 017.32	4 230.77

Модель/арт. WQ с АТМ	Скорость, об/мин	DN	Цена розница WQ, USD с НДС		
			с АТМ	под гибкий шланг/ под АТМ	колесо с фланцем
4-х полюсные					
80WQ36-10-2.2AC(I)	1450	90	1 983.25	1 335.30	1 407.71
80WQ36-12-2.2AC(I)	1450	90	1 983.25	1 335.30	1 407.71
80WQ36-16-4AC(I)	1450	90	2 214.48	1 566.53	1 638.95
80WQ60-11-4AC(I)	1450	92	2 214.48	1 566.53	1 638.95
100WQ60-17-5.5AC(I)	1450	100	2 811.62	1 945.14	2 049.32
100WQ60-20-7.5AC(I)	1450	100	3 007.27	2 140.79	2 243.70
100WQ80-35-18.5AC(I)	1460	100	5 707.09	4 840.61	4 947.33
100WQ100-35-22AC(I)	1460	100	по запросу		
100WQ100-39-22AC(I)	1460	100			
150WQ240-7-7.5AC(I)	1450	150	3 594.24	2 026.45	2 239.89
150WQ150-16-11AC(I)	1440	150	5 172.21	3 604.41	3 817.85
150WQ150-20-15AC(I)	1440	150	5 585.12	4 017.32	4 230.77
150WQ150-24-18.5AC(I)	1460	150	6 518.94	4 951.14	5 164.58
150WQ180-20-18.5AC(I)	1460	150	6 518.94	4 951.14	5 164.58
150WQ250-14-18.5AC(I)	1460	150	6 518.94	4 951.14	5 164.58
150WQ200-16-18.5AC(I)	1460	150	6 518.94	4 951.14	5 164.58
150WQ150-27-22AC(I)	1460	150			
150WQ180-25-22AC(I)	1460	150			
150WQ200-22-22AC(I)	1460	150			

150WQ270-16-22AC(I)	1460	150	по запросу					
150WQ200-28-30AC(I)	1450	150						
150WQ200-35-37AC(I)	1470	150						
150WQ150-35-37AC(I)	1470	150						
150WQ200-45-55AC(I)	1480	150						
150WQ270-40-55AC(I)	1480	150	по запросу					
200WQ270-10-11AC(I)	1440	200				5 675.32	3 869.94	4 148.18
200WQ270-14-15AC(I)	1440	200				6 052.66	4 247.28	4 526.79
200WQ250-15-18.5AC(I)	1460	200				6 925.50	5 120.12	5 398.35
200WQ300-12-18.5AC(I)	1460	200				6 925.50	5 120.12	5 398.35
200WQ270-16-22AC(I)	1450	200	по запросу					
200WQ300-15-22AC(I)	1450	200						
200WQ400-10-22AC(I)	1450	200						
200WQ360-17-30AC(I)	1450	200						
200WQ400-15-30AC(I)	1450	200						
200WQ250-22-30AC(I)	1450	200						
200WQ270-28-37AC(I)	1470	200						
200WQ300-26-37AC(I)	1450	200						
200WQ350-25-37AC(I)	1450	200						
200WQ400-25-45AC(I)	1470	200						
200WQ400-22-37AC(I)	1450	200						
200WQ250-40-55AC(I)	1450	200						
200WQ400-30-55AC(I)	1450	200						
200WQ350-40-75AC(I)	1450	200						
200WQ500-30-75AC(I)	1470	200						
250WQ400-15-30AC(I)	1460	250						
250WQ600-9-30AC(I)	1450	250						
250WQ360-20-30AC(I)	1450	250						
250WQ420-22-37AC(I)	1470	250						
250WQ600-12-37AC(I)	1450	250						
250WQ360-28-45AC(I)	1470	250						
250WQ600-28-75AC(I)	1450	250						
300WQ800-8-37AC(I)	1450	300						
300WQ500-15-37AC(I)	1450	300						
300WQ600-18-45AC(I)	1470	300						
300WQ800-12-45AC(I)	1450	300						
300WQ600-20-55AC(I)	1450	300						
300WQ800-20-75AC(I)	1450	300						
250WQ600-10-22-6AC(I)	983	250						
300WQ700-8-22-6AC(I)	983	300						
300WQ800-9-30-6AC(I)	983	300						
300WQ800-11-37-6AC(I)	983	300						
300WQ900-13-45-6AC(I)	983	300						
300WQ900-16-55-6AC(I)	983	300						
350WQ960-5.5-22-8AC(I)	734	350						
350WQ960-7-30-6AC(I)	983	350						
350WQ1100-8-37-6AC(I)	983	350						

400WQ1600-6.5-45-6AC(I)	983	400			
400WQ1600-9-55-6AC(I)	983	400			
400WQ1200-16-75-6AC(I)	983	400			
500WQ2000-9-75-6AC(I)	983	500			
WQ*JY с перемешивающим механизмом					
Модель/арт. WQ с АТМ	Скорость, об/мин	DN	Цена розница WQ, USD с НДС		
			с АТМ	под гибкий	колесо с
2-х полюсные					
50WQ9-7-0.55JYAC(I)	2850	40	900.78	548.86	593.32
50WQ12-10-0.75JYAC(I)	2850	40	900.78	548.86	593.32
50WQ7-15-1.1JYAC(I)	2850	40	951.60	599.68	635.25
50WQ15-15-1.5JYAC(I)	2880	50	1 049.43	697.50	743.24
50WQ15-18-2.2JYAC(I)	2880	50	1 170.13	818.20	861.40
50WQ15-25-3JYAC(I)	2840	50	1 236.20	884.27	927.47
50WQ15-32-4JYAC(I)	2840	50	1 593.21	1 241.28	1 285.75
50WQ15-38-5.5JYAC(I)	2940	50	1 760.91	1 408.98	1 453.45
65WQ15-10-1.1JYAC(I)	2850	65	1 078.65	599.68	658.12
65WQ25-9-1.5JYAC(I)	2850	65	1 195.54	716.56	775.01
65WQ25-13-2.2JYAC(I)	2880	65	1 297.18	818.20	875.37
65WQ35-9-2.2JYAC(I)	2880	65	1 297.18	818.20	875.37
65WQ25-18-3JYAC(I)	2840	65	1 363.25	884.27	941.44
65WQ20-27-4JYAC(I)	2840	65	1 720.26	1 241.28	1 299.72
65WQ25-30-5.5JYAC(I)	2940	65	1 887.96	1 408.98	1 467.43
65WQ35-50-11JYAC(I) ductile iron	2930	65	3 381.53	2 902.55	2 960.99
65WQ30-54-11JYAC(I) ductile iron	2930	65	3 381.53	2 902.55	2 960.99
80WQ40-10-2.2JYAC(I)	2880	80	1 478.86	830.91	905.87
80WQ35-13-3JYAC(I)	2840	80	1 550.01	902.06	977.01
80WQ40-15-4JYAC(I)	2840	80	1 896.86	1 248.90	1 323.86
80WQ40-22-5.5JYAC(I)	2940	80	2 114.11	1 466.16	1 541.12
80WQ40-30-7.5JYAC(I)	2940	80	2 704.89	2 056.94	2 131.90
80WQ50-29-11JYAC(I)	2930	80	3 727.67	3 079.72	3 154.68
100WQ50-7-2.2JYAC(I)	2880	100	1 697.39	830.91	938.90
100WQ50-10-3JYAC(I)	2840	100	1 783.78	917.30	1 025.29
100WQ50-12-4JYAC(I)	2840	100	2 115.38	1 248.90	1 356.89
100WQ75-12-4JYAC(I)	2840	100	2 115.38	1 248.90	1 356.89
100WQ65-15-5.5JYAC(I)	2940	100	2 368.21	1 501.73	1 608.45
100WQ70-18-7.5JYAC(I)	2940	100	2 950.10	2 083.62	2 190.34
100WQ100-15-7.5JYAC(I)	2940	100	2 950.10	2 083.62	2 190.34
100WQ100-22-11JYAC(I)	2930	100	4 186.72	3 320.24	3 428.23
100WQ100-30-15JYAC(I)	2930	100	4 789.30	3 922.82	4 030.81
100WQ100-35-22JYAC(I)	1460	100	по запросу		
150WQ100-10-7.5JYAC(I)	1450	150	3 694.61	2 126.82	2 340.26
150WQ140-10-7.5JYAC(I)	1450	150	3 694.61	2 126.82	2 340.26
150WQ150-13-11JYAC(I)	1440	150	5 666.07	4 098.27	4 311.71

150WQ140-24-15JYAC(I)	2930	150	4 844.59	3 276.79	3 490.23
150WQ150-19-15JYAC(I)	1440	150	6 221.63	4 653.83	4 867.27
150WQ200-17-18.5JYAC(I)	1460	150	8 160.11	6 592.31	6 805.75
150WQ250-15-18.5JYAC(I)	1460	150	8 160.11	6 592.31	6 805.75
150WQ150-25-22JYAC(I)	1460	150	по запросу		
150WQ300-16-22JYAC(I)	1460	150			
200WQ210-11-11JYAC(I)	1440	200	6 058.12	4 252.74	4 530.25
200WQ300-11-15JYAC(I)	1440	200	6 384.76	4 579.38	4 856.89
200WQ300-13-18.5JYAC(I)	1460	200	8 929.86	7 124.48	7 401.99

WQ-X погружные электронасосы для отвода канализационных сточных вод с Vortex колесом

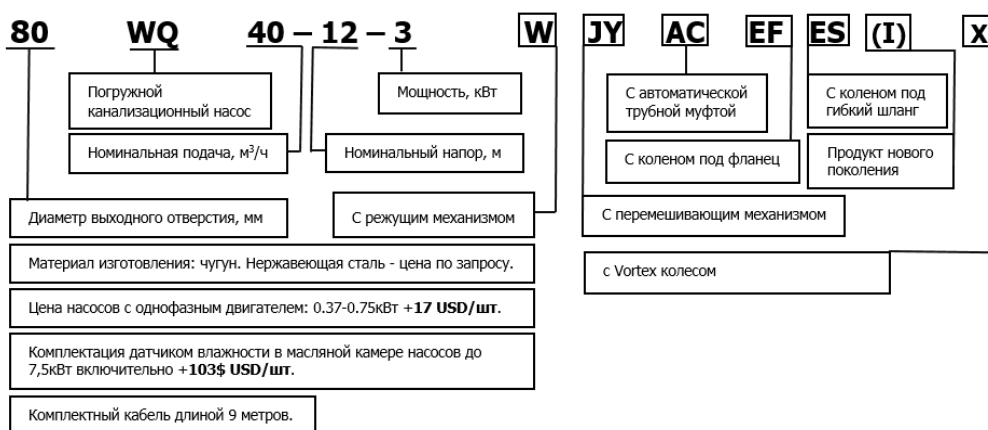

04.2022

Модель/арт. WQX с АТМ	Скорость, об/мин	DN	Цена розница WQ, USD с НДС		
			с АТМ	под гибкий	колено с
50WQX10-8-0.75AC(I)	2840	50	1 098.45	746.52	809.31
50WQX12-10-1.5AC(I)	2840	50	1 318.21	966.29	1 029.07
65WQX25-9-1.5AC(I)	2840	65	1 445.26	966.29	1 056.54
80WQX35-9-2.2AC(I)	2840	80	2 053.80	1 405.85	1 543.20
80WQX50-12-4AC(I)	2840	80	2 413.23	1 765.28	1 902.63



Погружные электронасосы WQ-W для отвода канализационных сточных вод с режущим механизмом

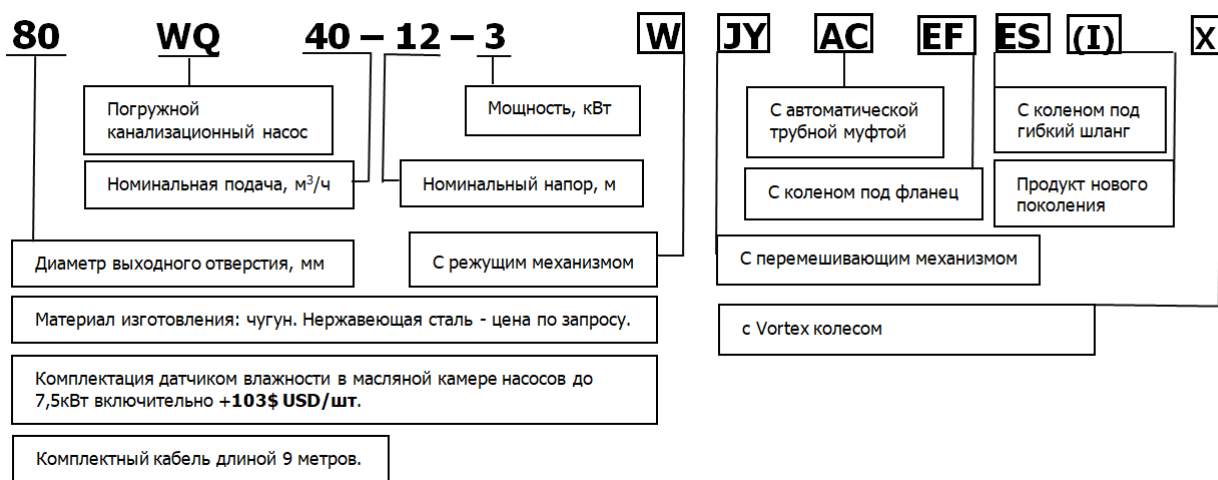

обновление
25.05.2022

Модель/арт. WQ-W с АТМ	Скорость, об/мин	DN	Цена розница WQ, USD с НДС		
			с АТМ	под гибкий шланг/ под АТМ	колено с фланцем
40WQ9-5-0.37ACW(I)	2800	40	903.70	598.67	635.00
40WQ10-7-0.55ACW(I)	2840	40	905.87	603.49	637.79
40WQ10-10-0.75ACW(I)	2840	40	950.33	647.96	684.80
40WQ12-15-1.5ACW(I)	2840	40	1 140.91	838.53	875.37
50WQ10-13-1.1ACW(I)	2840	50	1 035.46	683.53	726.73
50WQ10-7-0.55ACW(I)	2840	50	955.42	603.49	646.68
50WQ10-10-0.75ACW(I)	2840	50	999.88	647.96	692.42
50WQ12-15-1.5ACW(I)	2840	50	1 190.46	838.53	883.00
50WQ15-18-2.2ACW(I)	2840	50	1 365.79	1 013.86	1 058.33
50WQ15-25-3ACW(I)	2840	50	1 577.96	1 226.03	1 269.23
50WQ25-25-4ACW(I)	2840	50	1 882.88	1 530.95	1 576.69
50WQ18-32-5.5ACW(I)	2840	50	2 144.60	1 792.68	1 837.14
65WQ15-10-1.1ACW(I)	2840	65	1 162.51	683.53	741.97
65WQ25-10-1.5ACW(I)	2840	65	1 317.51	838.53	896.97
65WQ25-14-2.2ACW(I)	2840	65	1 492.84	1 013.86	1 072.30

65WQ25-18-3ACW(I)	2840	65	1 705.01	1 226.03	1 284.48
65WQ40-16-4ACW(I)	2840	65	2 009.93	1 530.95	1 589.40
65WQ30-25-5.5ACW(I)	2840	65	2 361.86	1 882.88	1 941.32
65WQ45-28-7,5ACW(I)	2840	65	2 858.63	2 379.65	2 433.01
80WQ40-8-2,2ACW(I)	2840	80	1 711.36	1 063.41	1 139.64
80WQ35-13-3ACW(I)	2840	80	1 934.97	1 287.02	1 361.98
80WQ40-22-5.5ACW(I)	2840	80	2 619.77	1 971.82	2 046.78
80WQ50-12-4ACW(I)	2840	80	2 255.14	1 607.18	1 682.14
100WQ50-10-3ACW(I)	2840	100	2 214.48	1 348.00	1 422.96
100WQ60-11-4ACW(I)	2840	100	2 549.89	1 683.41	1 792.68
100WQ65-15-5.5ACW(I)	2840	100	3 035.22	2 168.74	2 278.01
100WQ70-17-7.5ACW(I)	2840	100	3 110.18	2 243.70	2 352.97
150WQ140-10-7.5ACW(I)	2840	150	3 971.58	2 403.79	2 618.50
150WQ140-14-11ACW(I)	1440	150	5 344.99	3 777.20	3 990.64
150WQ200-16-15ACW(I)	1440	150	5 820.16	4 252.36	4 467.08
200WQ210-10-11ACW(I)*	1440	200	5 883.69	4 078.31	4 346.38
200WQ300-10-15ACW(I)*	1440	200	6 281.35	4 475.97	6 175.90

Погружные однофазные электронасосы WQ-D для отвода канализационных сточных вод

обновление
25.04.2022

Модель/арт. WQD с АТМ	Материал	Мощность, кВт	Скорость, об/мин	Цена розница, USD с НДС		
				с АТМ	под гибкий шланг/ под АТМ	колесо с фланцем
40WQD12-10-0.75AC(I)	HT200/GG20	1	2850	924.91	622.53	678.93
40WQD12-18-1.5AC(I)	HT200/GG20	2	2880	1 144.72	842.34	898.74
50WQD10-15-1.5AC(I)	HT200/GG20	2	2880	1 194.27	842.34	933.76
50WQD10-18-1.5AC(I)	HT200/GG20	2	2880	1 194.27	842.34	933.76
50WQD12-10-0.75AC(I)	HT200/GG20	1	2850	976.58	624.66	716.07
50WQD12-12-1.5AC(I)	HT200/GG20	2	2880	1 194.27	842.34	933.76
50WQD15-10-1.5AC(I)	HT200/GG20	2	2880	1 194.27	842.34	933.76
50WQD15-15-1.5AC(I)	HT200/GG20	2	2880	1 184.12	832.19	923.61
50WQD15-18-2.2AC(I)	HT200/GG20	2	2880	1 333.86	981.93	1073.35
50WQD15-20-2.2AC(I)	HT200/GG20	2	2880	1 322.63	970.70	1062.11
50WQD20-15-2.2AC(I)	HT200/GG20	2	2880	1 333.86	981.93	1073.35
50WQD25-10-2.2AC(I)	HT200/GG20	2	2880	1 333.86	981.93	1073.35
50WQD9-22-2.2AC(I)	HT200/GG20	2	2880	1 333.86	981.93	1073.35
65WQD25-10-1.5AC(I)	HT200/GG20	2	2850	1 460.91	981.93	1073.35
65WQD25-14-2.2AC(I)	HT200/GG20	2	2880	1 558.26	1 079.28	1170.70
65WQD35-7-2.2AC(I)	HT200/GG20	2	2880	1 545.94	1 066.97	1158.38
80WQD40-10-2.2AC(I)	HT200/GG20	2	2880	1 774.29	1 126.33	1263.44
80WQD40-8-2.2AC(I)	HT200/GG20	2	2880	1 774.29	1 126.33	1263.44
80WQD45-9-2.2AC(I)	HT200/GG20	2	2880	1 774.29	1 126.33	1263.44
100WQD50-7-2.2AC(I)	HT200/GG20	2	2880	2 199.79	1 333.31	1485.00

Цена указана для напряжения 1x220В, при необходимости комплектации электродвигателем под другое напряжения цена увеличивается на 5%.

Погружные электронасосы WQ Н для отвода канализационных сточных вод

обновление 01.06.2022

Комплектация насосов серии WQ ATM		
Модель ATM	Применяется для	Примечание
TOS-40~150 TO-150~500	Насосы WQ мощностью более 0.55 кВт (за исключением 4-х полюсных моделей DN100 мощностью 18.5-22 кВт и насосов серии WQ-H).	Стандартная автоматическая трубная муфта
TOS-80F TOS-100F	4-х полюсные насосы с напорным патрубком DN100 и мощностью 18.5-22 кВт (например, 100WQ100-39-22AC(I); насосы серии WQ-H).	Усиленная автоматическая трубная муфта

Особенности: высокий напор, спиральное рабочее колесо, высокая эффективность, конструкция для более тяжелых условий эксплуатации

Модель	Скорость, об/мин	Материал	Мощность, кВт	Цена розница WQ, USD с НДС		
				с ATM	под гибкий шланг/ под ATM	колесо с фланцем
80WQ60-28-11H(I)	1440	HT200/GG20	11	5 258.65	4 610.70	7 241.45
80WQ60-35-15H(I)	1440	HT200/GG20	15	5 318.54	4 670.58	7 244.66
80WQ60-40-18.5H(I)	1460	HT200/GG20	18.5	7 186.13	6 538.17	11 689.01
80WQ80-43-22H(I)	1460	HT200/GG20	22	по запросу		
100WQ100-22-11H(I)	1440	HT200/GG20	11	5 360.57	4 494.09	7 087.42
100WQ100-29-15H(I)	1440	HT200/GG20	15	5 360.57	4 494.09	7 087.42
100WQ100-32-18.5H(I)	1460	HT200/GG20	18.5	7 227.08	6 360.60	11 530.17
100WQ100-34-22H(I)	1460	HT200/GG20	22	по запросу		

Примечание:

Цена указана на насосы с подключением 380В, отличное от стандартного +5% к розничной цене

Топ версия: механическое уплотнение: Burgmann, маслоподъемник: Япония

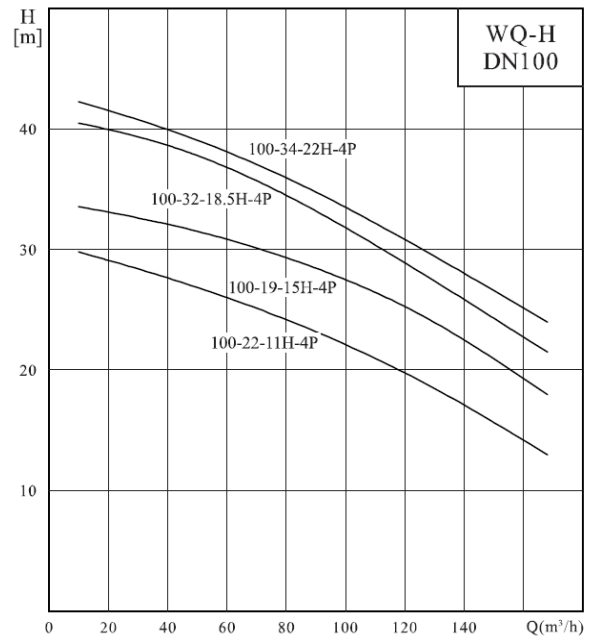
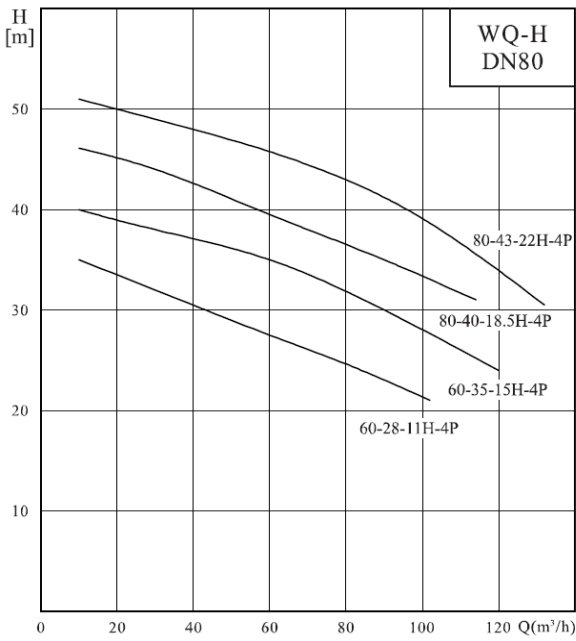
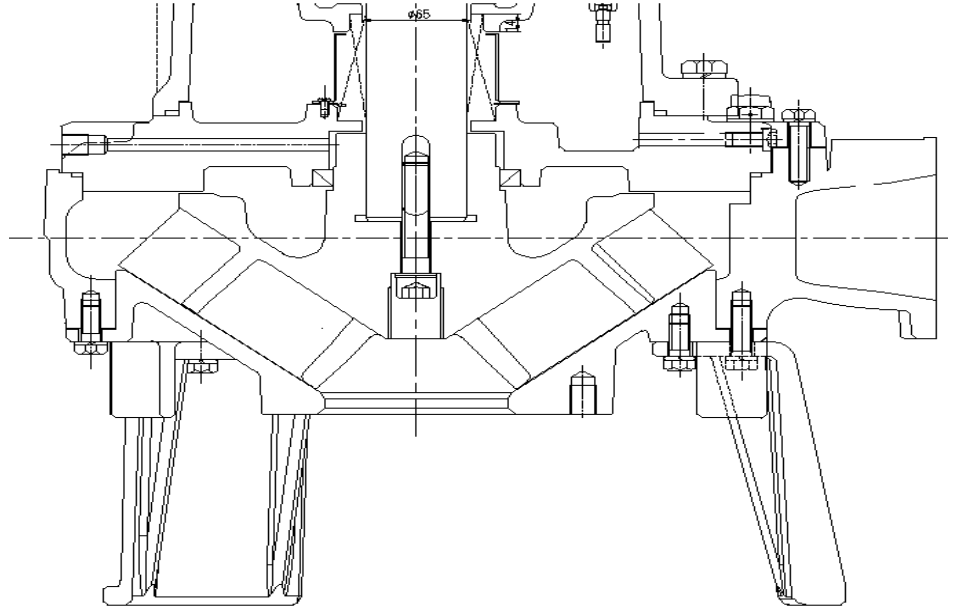
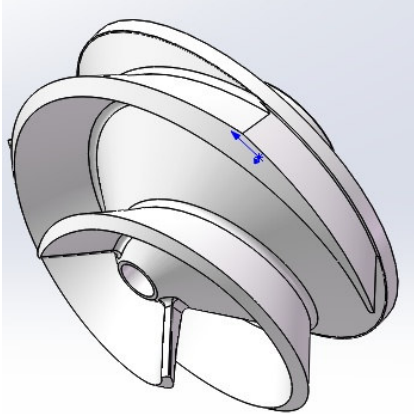



Погружные электронасосы WQ-QG для отвода канализационных сточных вод с режущим механизмом

обновление
27.06.2022

Модель/арт. WQ-QG с АТМ	Скорость, об/мин	DN	Цена розница WQ, USD с НДС		
			с АТМ	под гибкий шланг/ под АТМ	колесо с фланцем
32WQ6-20-1.1/QG(I)	2850	32		670.31	724.15
50WQ10-10-0.75/QG(I)	2850	50	987.51	635.58	696.85
50WQ10-15-1.1/QG(I)	2850	50	1 022.24	670.31	731.57
50WQ15-15-1.5/ QG(I)	2880	50	1 174.86	822.93	884.19
50WQ15-20-2.2/QG(I)	2880	50	1 347.42	995.49	1 056.76
50WQ15-28-3/QG(I)	2840	50	1 555.21	1 203.28	1 264.55
50WQ25-27-4/QG(I)	2840	50	1 855.89	1 503.96	1 565.22
80WQ25-15-2.2/QG(I)	2880	80	2 016.65	1 368.69	1 499.56
80WQ40-12-3/QG(I)	2840	80	1 966.10	1 318.15	1 449.02
80WQ40-17-4/QG(I)	2840	80	2 151.92	1 503.96	1 634.84
80WQ50-22-5.5/QG(I)	2940	80	2 585.84	1 937.88	2 068.76
80WQ45-29-7.5/QG(I)	2940	80	2 969.26	2 321.30	2 452.17
80WQ35-40-11/QG(I)	2930	80	4 499.26	3 851.30	3 982.17
80WQ36-10-2.2/QG(I)	1413	80	2 124.85	1 476.89	1 607.77
80WQ60-11-4/QG(I)	1413	80	2 346.42	1 698.47	1 829.34

Принадлежности для насосов всех серий WQ

Автоматическая трубная муфта для насосов WQ (WQ-W)

Комплектация насосов серии WQ ATM		
Модель ATM	Применяется для	Примечание
TOS-40~150 TO-150~500	Насосы WQ мощностью более 0.55 кВт (за исключением 4-х полюсных моделей DN100 мощностью 18.5-22 кВт и насосов серии WQ-H).	Стандартная автоматическая трубная муфта
TOS-80F TOS-100F	4-х полюсные насосы с напорным патрубком DN100 и мощностью 18.5-22 кВт (например, 100WQ100-39-22AC(I); насосы серии WQ-H).	Усиленная автоматическая трубная муфта

Наименование	Артикул	Цена розн., USD/шт., с НДС
Автоматическая трубная муфта DN40	TOS-40	302.38
Автоматическая трубная муфта DN50	TOS-50	351.93
Автоматическая трубная муфта DN65	TOS-65	478.98
Автоматическая трубная муфта DN80	TOS-80	647.96
Автоматическая трубная муфта DN100	TOS-100	866.48
Автоматическая трубная муфта DN150 (до 22 кВт)	TOS-150	1 567.80
Автоматическая трубная муфта DN150 (свыше 30 кВт)	TO-150	1 567.80
Автоматическая трубная муфта DN200	TO-200	1 805.38
Автоматическая трубная муфта DN250	TO-250	2 501.61
Автоматическая трубная муфта DN300	TO-300	3 789.90



Поплавковый датчик уровня (канализация)

Наименование	Артикул	Цена розн., USD/шт., с НДС
Поплавковый датчик уровня FS-1-10 для канализации (кабель 10 м)	FS-1-10	78.54
Поплавковый датчик уровня FS-1-20 для канализации (кабель 20 м)	FS-1-20	110.88

Поплавковый датчик уровня (чистая вода)



Наименование	Артикул	Цена розн., USD/шт., с НДС
Поплавковый датчик уровня FS-2-7 для чистой воды (кабель 7 м)	FS-2-7	21.78
Поплавковый датчик уровня FS-2-10 для чистой воды (кабель 10 м)	FS-2-10	27.83

Датчики для WQ

Наименование	Цена розн., USD/шт.,с НДС
Датчик протечки воды в масляную камеру WQ(W) для насосов мощность до 7,5кВт включительно	49.55
Датчик температуры двигателя PT100 для P>30кВт	24.14

Комплектный кабель для WQ (отгрузка кратно 5 метрам)

Мощность, кВт	Сечение кабеля, мм2	Цена USD, с НДС		Сечение кабеля, мм2	+ к стоимости прямого пуска	Цена USD, с НДС	
		кабель (\$/пог.м.)	крышка гермоввода (\$/шт)			кабель (\$/пог.м.)	крышка гермоввода (\$/шт)
прямой пуск				звезда/треугольник			
0.55~1.1	4×0.75	5.13	8.66	-	-	-	-
1.5~2.2	4×1	6.53	13.02	-	-	-	-
3~4	4×1.5	9.05	13.02	-	-	-	-
5.5~7.5	4×2.5	12.92	13.02	-	-	-	-
11	4×4	20.67	17.96	4×2.5+3×2.5	201.78	33.59	273.61
15	4×6	28.99	17.96	4×2.5+3×2.5	201.78	41.91	273.61
18.5~22	4×10	48.45	50.58	4×6+3×6	277.04	77.44	479.35
30	4×16	66.79	78.50	4×6+3×6	277.04	95.78	591.06
37	4×25	103.77	78.50	4×10+3×10	481.43	152.22	795.45
45	4×25	103.77	78.50	4×10+3×10	481.43	152.22	795.45
55.00	4×25	103.77	78.50	4×16+3×16	481.43	170.56	795.45
75.00	4×25	103.77	78.50	4×25+3×25	481.43	207.54	795.45



SDS погружные дренажные насосы

В цену включена стоимость поплавкового датчика уровня и кабеля длиной 8 м.

обновление
11.07.2022

Модель/арт. WQ с АТМ	Питающее напряжение, В	Частота вращения, об/мин	Мощность, кВт	Напорный патрубок, мм	Цена розница (USD) с НДС
SDS MF2.25	1x220	2850	0,25	50	787.71
SDS MF2.4	1x220	2850	0,4	50	853.78
SDS MF2.75	1x220	2850	0,75	50	853.78

NES АГРЕГАТЫ ЭЛЕКТРОНАСОСНЫЕ КОНСОЛЬНО-МОНОБЛОЧНЫЕ по стандарту EN733

NES(0) 100 - 80 - 320(300) - 18,5/ 2 x x x



Цены указаны для насосов NES следующего конструктива:
Насосная часть - чугун, рабочее колесо - чугун, торцевое уплотнение, вал - нерж. сталь (CI-CI-SS-MS)
Стоимость насоса вертикальной установки: до 45кВт +15%, свыше 45кВт +10% к прайсовой цене

обновление 25.04.2022

Насосные агрегаты комплектуются двигателями с классом защиты IP55 в стандартном исполнении (по цене агрегата с двигателем IP54)!!!

Модель агрегата	Мощность, кВт	Цена розница USD с НДС	Артикул	Модель агрегата	Мощность, кВт	Цена розница USD с НДС	Артикул
2-х полюсные, 50Гц, 2900 об/мин							
50-32-130	2.2	791.26	NES50-32-130-2.2/2SWH	80-65-130	5.5	1 261.95	NES80-65-130-5.5/2SWH
	1.5	763.50	NES50-32-130-1.5/2SWH		4	1 084.08	NES80-65-130-4/2SWH
	1.1	700.26	NES50-32-130-1.1/2SWH		11	1 954.81	NES80-65-130-11/2SWH
50-32-160	5.5	1 006.12	NES50-32-160-5.5/2SWH	80-65-160	7.5	1 361.55	NES80-65-130-7.5/2SWH
	4	1 006.12	NES50-32-160-4/2SWH		18.5	2 290.09	NES80-65-160-18.5/2SWH
	3	940.30	NES50-32-160-3/2SWH		15	2 151.31	NES80-65-160-15/2SWH
50-32-200	2.2	834.09	NES50-32-160-2.2/2SWH	80-65-200H	11	2 068.05	NES80-65-160-11/2SWH
	1.5	806.77	NES50-32-160-1.5/2SWH		7.5	1 702.47	NES80-65-160-7.5/2SWH
	11	1 814.27	NES50-32-200-11/2SWH		30	3 191.17	NES80-65-200H-30/2SWH
50-32-260	7.5	1 366.14	NES50-32-200-7.5/2SWH	80-65-260	22	2 593.79	NES80-65-200H-22/2SWH
	5.5	1 319.88	NES50-32-200-5.5/2SWH		18.5	2 209.92	NES80-65-200H-18.5/2SWH
	4	1 221.23	NES50-32-200-4/2SWH		15	2 071.15	NES80-65-200H-15/2SWH
65-40-130	18.5	2 273.79	NES50-32-260-18.5/2SWH	80-65-320H	55	по запросу	NES80-65-260-55/2SWH
	15	2 135.02	NES50-32-260-15/2SWH		45	4 020.71	NES80-65-260-45/2SWH
	11	2 132.86	NES50-32-260-11/2SWH		37	3 443.62	NES80-65-260-37/2SWH
65-40-160	4	979.51	NES65-40-130-4/2SWH	100-80-160	30	3 226.21	NES80-65-260-30/2SWH
	3	893.23	NES65-40-130-3/2SWH		90	по запросу	NES80-65-320H-90/2SWH
	2.2	805.44	NES65-40-130-2.2/2SWH		75	по запросу	NES80-65-320H-75/2SWH
65-40-200	1.5	778.82	NES65-40-130-1.5/2SWH	100-80-200	55	по запросу	NES80-65-320H-55/2SWH
	7.5	1 485.59	NES65-40-160-7.5/2SWH		45	6 158.11	NES80-65-320H-45/2SWH
	5.5	1 468.81	NES65-40-160-5.5/2SWH		30	3 118.11	NES100-80-160-30/2SWH
65-40-260	4	1 141.78	NES65-40-160-4/2SWH	100-80-260	22	2 667.36	NES100-80-160-22/2SWH
	3	1 097.71	NES65-40-160-3/2SWH		18.5	2 154.17	NES100-80-160-18.5/2SWH
	11	1 993.29	NES65-40-200-11/2SWH		11	1 932.82	NES100-80-160-11/2SWH
65-40-320H	7.5	1 388.11	NES65-40-200-7.5/2SWH	100-80-260	15	2 015.40	NES100-80-160-15/2SWH
	5.5	1 341.85	NES65-40-200-5.5/2SWH		45	4 046.42	NES100-80-200-45/2SWH
	22	2 857.83	NES65-40-260-22/2SWH		37	3 531.66	NES100-80-200-37/2SWH
65-40-320H	18.5	2 377.64	NES65-40-260-18.5/2SWH	100-80-260	30	3 314.25	NES100-80-200-30/2SWH
	15	2 110.34	NES65-40-260-15/2SWH		22	2 731.58	NES100-80-200-22/2SWH
	45	4 680.06	NES65-40-320H-45/2SWH		75	по запросу	NES100-80-260-75/2SWH
65-40-320H	37	4 097.67	NES65-40-320H-37/2SWH	100-80-260	55	по запросу	NES100-80-260-55/2SWH
	30	3 835.89	NES65-40-320H-30/2SWH		45	4 280.80	NES100-80-260-45/2SWH

65-50-130	22	3 196.45	NES65-40-320H-22/2SWH
	7.5	1 257.19	NES65-50-130-7.5/2SWH
	5.5	1 210.93	NES65-50-130-5.5/2SWH
	3	946.66	NES65-50-130-3/2SWH
65-50-160	4	1 015.34	NES65-50-130-4/2SWH
	11	1 874.05	NES65-50-160-11/2SWH
	7.5	1 323.05	NES65-50-160-7.5/2SWH
65-50-200	5.5	1 276.79	NES65-50-160-5.5/2SWH
	18.5	2 151.51	NES65-50-200-18.5/2SWH
	15	2 012.73	NES65-50-200-15/2SWH
65-50-260H	11	2 021.69	NES65-50-200-11/2SWH
	7.5	1 929.47	NES65-50-200-7.5/2SWH
	37	3 936.99	NES65-50-260H-37/2SWH
	30	3 675.21	NES65-50-260H-30/2SWH
65-50-320H	22	2 666.89	NES65-50-260H-22/2SWH
	18.5	2 285.63	NES65-50-260H-18.5/2SWH
	75	по запросу	NES65-50-320H-75/2SWH
	55	по запросу	NES65-50-320H-55/2SWH
	45	4 657.73	NES65-50-320H-45/2SWH
	37	4 102.44	NES65-50-320H-37/2SWH
	30	3 867.30	NES65-50-320H-30/2SWH

100-80-320H	132	по запросу	NES100-80-320H-132/2SWH	
	110		NES100-80-320H-110/2SWH	
	90		NES100-80-320H-90/2SWH	
	75		NES100-80-320H-75/2SWH	
125-100-160	30	3 837.67	NES125-100-160-30/2SWH	
	22	3 196.45	NES125-100-160-22/2SWH	
	18.5	2 807.81	NES125-100-160-18.5/2SWH	
125-100-200	15	2 680.76	NES125-100-160-15/2SWH	
	75	по запросу	NES125-100-200-75/2SWH	
	55		NES125-100-200-55/2SWH	
	45	4 199.41	NES125-100-200-45/2SWH	
	37	3 697.59	NES125-100-200-37/2SWH	
125-100-260	30	3 462.11	NES125-100-200-30/2SWH	
	110	по запросу	NES125-100-260-110/2SWH	
	132		NES125-100-260-132/2SWH	
	90		NES125-100-260-90/2SWH	
75	NES125-100-260-75/2SWH			
150-125-200	90	по запросу	NES150-125-200-90/2SWH	
	75		NES150-125-200-75/2SWH	
	55		NES150-125-200-55/2SWH	
	45		6 779.39	NES150-125-200-45/2SWH
	132		NES125-100-320-132/2SWH	
125-100-320	110	по запросу	NES125-100-320-110/2SWH	
	90		NES125-100-320-90/2SWH	
	200		NES150-125-260-200/2SWH	
150-125-260	132	по запросу	NES150-125-260-132/2SWH	
	110		NES150-125-260-110/2SWH	
	90		NES150-125-260-90/2SWH	

Модель агрегата	Мощность, кВт	Цена розница USD с НДС	Артикул
-----------------	---------------	------------------------	---------

Модель агрегата	Мощность, кВт	Цена розница USD с НДС	Артикул
-----------------	---------------	------------------------	---------

4-х полюсные, 50Гц, 1450об/мин

50-32-130	0.55	677.14	NES50-32-130-0.55/4SWH
	0,37(0,55)	677.14	NES50-32-130-0.37(0.55)/4SWH
50-32-160	0.55	734.07	NES50-32-160-0.55/4SWH
50-32-200	1.1	991.21	NES50-32-200-1.1/4SWH
	0.75	859.32	NES50-32-200-0.75/4SWH
50-32-260	0.55	833.91	NES50-32-200-0.55/4SWH
	3	1 270.10	NES50-32-260-3/4SWH
	2.2	1 228.47	NES50-32-260-2.2/4SWH
65-40-130	1.5	1 128.24	NES50-32-260-1.5/4SWH
	0.55	691.44	NES65-40-130-0.55/4SWH
	0,37(0,55)	691.44	NES65-40-130-0.37(0.55)/4SWH
65-40-160	1.1	927.72	NES65-40-160-1.1/4SWH
	0.75	780.97	NES65-40-160-0.75/4SWH
	0.55	762.47	NES65-40-160-0.55/4SWH
65-40-200	1.5	967.65	NES65-40-200-1.5/4SWH
	0.75	916.83	NES65-40-200-0.75/4SWH
	1.1	944.52	NES65-40-200-1.1/4SWH
65-40-260	3	1 245.42	NES65-40-260-3/4SWH
	1.5	1 140.27	NES65-40-260-1.5/4SWH
	2.2	1 203.79	NES65-40-260-2.2/4SWH
65-40-320	7.5	1 964.55	NES65-40-320-7.5/4SWH
	5.5	1 847.73	NES65-40-320-5.5/4SWH
	4	1 658.00	NES65-40-320-4/4SWH
65-50-130	1.1	810.39	NES65-50-130-1.1/4SWH
	0.55	727.93	NES65-50-130-0.55/4SWH
65-50-160	1.5	875.21	NES65-50-160-1.5/4SWH
	1.1	852.08	NES65-50-160-1.1/4SWH
	0.75	802.22	NES65-50-160-0.75/4SWH
65-50-200	2.2	1 081.89	NES65-50-200-2.2/4SWH
	1.1	1 020.21	NES65-50-200-1.1/4SWH
	1.5	1 043.08	NES65-50-200-1.5/4SWH
65-50-260	5.5	1 617.89	NES65-50-260-5.5/4SWH
	4	1 346.17	NES65-50-260-4/4SWH
	3	1 276.49	NES65-50-260-3/4SWH
65-50-320	11	2 422.35	NES65-50-320-11/4SWH
	7.5	1 993.85	NES65-50-320-7.5/4SWH
	5.5	1 892.08	NES65-50-320-5.5/4SWH
80-65-130	1.5	884.60	NES80-65-130-1.5/4SWH
	0.75	829.71	NES80-65-130-0.75/4SWH
	1.1	861.48	NES80-65-130-1.1/4SWH
80-65-160	2.2	1 053.49	NES80-65-160-2.2/4SWH
	1.5	1 289.46	NES80-65-160-1.5/4SWH

125-100-160	4	1 541.12	NES125-100-160-4/4SWH
	2.2	1 248.90	NES125-100-160-2.2/4SWH
	3	1 287.02	NES125-100-160-3/4SWH
125-100-200	11	2 235.36	NES125-100-200-11/4SWH
	7.5	1 890.23	NES125-100-200-7.5/4SWH
	5.5	1 788.47	NES125-100-200-5.5/4SWH
125-100-260	4	1 571.65	NES125-100-200-4/4SWH
	15	2 630.11	NES125-100-260-15/4SWH
	11	2 445.08	NES125-100-260-11/4SWH
125-100-320	22	3 214.37	NES125-100-320-22/4SWH
	30	3 976.67	NES125-100-320-30/4SWH
	18.5	3 075.38	NES125-100-320-18.5/4SWH
125-100-400	15	2 761.28	NES125-100-320-15/4SWH
	45	5 600.39	NES125-100-400-45/4SWH
	37	5 288.43	NES125-100-400-37/4SWH
150-125-200	30	4 938.87	NES125-100-400-30/4SWH
	22	4 176.57	NES125-100-400-22/4SWH
	11	3 263.47	NES150-125-200-11/4SWH
150-125-260	7.5	2 036.77	NES150-125-200-7.5/4SWH
	22	3 187.68	NES150-125-260-22/4SWH
	30	3 949.98	NES150-125-260-30/4SWH
150-125-320	18.5	3 037.79	NES150-125-260-18.5/4SWH
	15	2 724.25	NES150-125-260-15/4SWH
	30	5 061.62	NES150-125-320-30/4SWH
150-125-400	22	4 291.93	NES150-125-320-22/4SWH
	18.5	4 167.04	NES150-125-320-18.5/4SWH
	15	3 671.75	NES150-125-320-15/4SWH
150-125-500	75	по запросу	NES150-125-400-75/4SWH
	55		NES150-125-400-55/4SWH
	45	5 516.25	NES150-125-400-45/4SWH
200-150-200	37	5 257.20	NES150-125-400-37/4SWH
	45	9 546.54	NESSMM150-125-500-45/4SWH
	18.5	3 464.41	NES200-150-200-18.5/4SWH
200-150-260	15	3 135.28	NES200-150-200-15/4SWH
	11	2 931.04	NES200-150-200-11/4SWH
	30	4 524.83	NES200-150-260-30/4SWH
200-150-320	22	3 902.52	NES200-150-260-22/4SWH
	18.5	3 777.63	NES200-150-260-18.5/4SWH
	55	по запросу	NES200-150-320-55/4SWH
200-150-400	45	5 350.83	NES200-150-320-45/4SWH
	37	5 091.79	NES200-150-320-37/4SWH
	30	4 524.83	NES200-150-320-30/4SWH

	1.1	1 251.44	NES80-65-160-1.1/4SWH
80-65-200	4	1 251.32	NES80-65-200-4/4SWH
	3	1 181.93	NES80-65-200-3/4SWH
	2.2	1 140.30	NES80-65-200-2.2/4SWH
80-65-260	7.5	1 857.94	NES80-65-260-7.5/4SWH
	5.5	1 756.17	NES80-65-260-5.5/4SWH
	3	1 477.40	NES80-65-260-3/4SWH
80-65-320	4	1 540.92	NES80-65-260-4/4SWH
	15	2 708.43	NES80-65-320-15/4SWH
	11	2 446.94	NES80-65-320-11/4SWH
100-80-160	7.5	2 065.34	NES80-65-320-7.5/4SWH
	3	1 149.17	NES100-80-160-3/4SWH
	2.2	1 107.54	NES100-80-160-2.2/4SWH
100-80-200	1.5	1 044.02	NES100-80-160-1.5/4SWH
	7.5	1 721.53	NES100-80-200-7.5/4SWH
	5.5	1 632.62	NES100-80-200-5.5/4SWH
100-80-260	3	1 364.81	NES100-80-200-3/4SWH
	4	1 415.63	NES100-80-200-4/4SWH
	11	2 342.40	NES100-80-260-11/4SWH
100-80-320	7.5	1 966.85	NES100-80-260-7.5/4SWH
	5.5	1 865.08	NES100-80-260-5.5/4SWH
	18.5	3 152.75	NES100-80-320-18.5/4SWH
100-80-400	15	2 715.91	NES100-80-320-15/4SWH
	11	2 530.88	NES100-80-320-11/4SWH
100-80-400	30	4 951.63	NES100-80-400-30/4SWH
	22	4 195.43	NES100-80-400-22/4SWH
	18.5	4 007.85	NES100-80-400-18.5/4SWH

200-150-400	90	по запросу	NES200-150-400-90/4SWH
	75		NES200-150-400-75/4SWH
	45		7 188.49
250-200-260	55	по запросу	NES200-150-400-55/4SWH
	30	5 174.42	NES250-200-260-30/4SWH
	22	4 552.28	NES250-200-260-22/4SWH
	18.5	4 427.39	NES250-200-260-18.5/4SWH
250-200-320	15	4 134.21	NES250-200-260-15/4SWH
	75	по запросу	NES250-200-320-75/4SWH
	55		NES250-200-320-55/4SWH
	45	6 975.77	NES250-200-320-45/4SWH
37	6 692.99	NES250-200-320-37/4SWH	
250-200-400	132	по запросу	NES250-200-400-132/4SWH
	110		NES250-200-400-110/4SWH
	90		NES250-200-400-90/4SWH
	55		NES250-200-400-55/4SWH
	75		NES250-200-400-75/4SWH
300-250-320	90	10 878.02	NES300-250-320-90/4SWH
	75		NES300-250-320-75/4SWH
	55		NES300-250-320-55/4SWH
	45		NES300-250-320-45/4SWH
300-250-400	160	по запросу	NES300-250-400-160/4SWH
	132		NES300-250-400-132/4SWH
	110		NES300-250-400-110/4SWH
	90		NES300-250-400-90/4SWH
	75		NES300-250-400-75/4SWH

NESO АГРЕГАТЫ ЭЛЕКТРОНАСОСНЫЕ КОНСОЛЬНЫЕ (стандарт EN733)

NES(0) 100 - 80 - 320(300) - 18,5/ 2 x x x

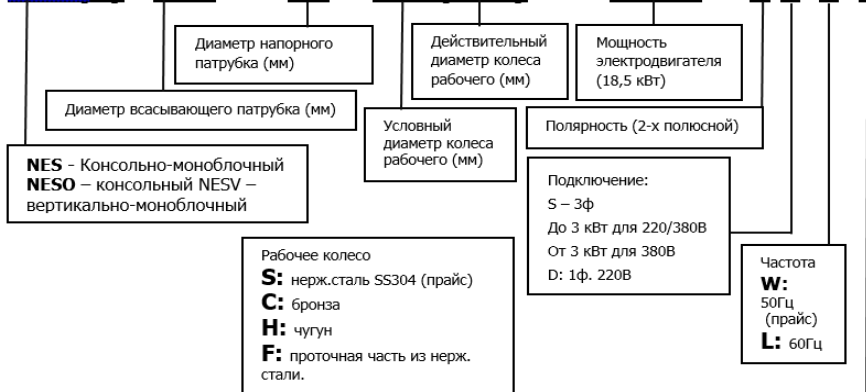

Цены указаны для насосов NES следующего конструктива:
Насосная часть - чугун, рабочее колесо - чугун, торцевое уплотнение, вал - нерж. сталь (CI-CI-SS-MS)

Стоимость насоса вертикальной установки: до 45кВт +15%, свыше 45кВт +10% к прайсовой цене

обновление 25.04.2022

Модель агрегата	Мощность, кВт	Цена розница USD с НДС	Артикул
2-х полюсные, 50Гц, 2900 об/мин			
50-32-130	2.2	1 734.54	NES050-32-130 -2.2/2SWH
	1.5	1 707.55	NES050-32-130 -1.5/2SWH
	1.1	1 679.50	NES050-32-130 -1.1/2SWH
	0.75	1 661.20	NES050-32-130 -0.75/2SWH
50-32-160	5.5	2 242.92	NES050-32-160 -5.5/2SWH
	4	2 117.75	NES050-32-160 -4/2SWH
	3	2 046.64	NES050-32-160 -3/2SWH
	2.2	1 968.14	NES050-32-160 -2.2/2SWH
50-32-200	1.5	1 921.06	NES050-32-160 -1.5/2SWH
	11	3 206.96	NES050-32-200 -11/2SWH
	7.5	2 661.89	NES050-32-200 -7.5/2SWH
	5.5	2 177.30	NES050-32-200 -5.5/2SWH
50-32-260	4	2 004.84	NES050-32-200 -4/2SWH
	18.5	3 431.60	NES050-32-260 -18.5/2SWH
	15	3 303.92	NES050-32-260 -15/2SWH
	11	3 176.84	NES050-32-260 -11/2SWH
65-40-130	4	1 859.80	NES065-40-130 -4/2SWH
	3	1 788.69	NES065-40-130 -3/2SWH
	2.2	1 710.19	NES065-40-130 -2.2/2SWH
	1.5	1 640.34	NES065-40-130 -1.5/2SWH
65-40-160	7.5	2 378.30	NES065-40-160 -7.5/2SWH
	5.5	2 316.98	NES065-40-160 -5.5/2SWH
	4	2 144.52	NES065-40-160 -4/2SWH
	3	2 018.25	NES065-40-160 -3/2SWH
65-40-200	11	2 985.24	NES065-40-200 -11/2SWH
	7.5	2 261.56	NES065-40-200 -7.5/2SWH
	5.5	2 200.24	NES065-40-200 -5.5/2SWH
	22	3 762.14	NES065-40-200 -22/2SWH
65-40-260	18.5	3 407.41	NES065-40-260 -18.5/2SWH
	15	3 279.74	NES065-40-260 -15/2SWH
	11	3 108.95	NES065-40-260 -11/2SWH
	45	5 993.07	NES065-40-320H-45/2SWH
65-40-320H	37	5 034.71	NES065-40-320H-37/2SWH
	30	4 779.46	NES065-40-320H-30/2SWH
	22	4 177.24	NES065-40-320H-22/2SWH
	7.5	2 144.33	NES065-50-130 -7.5/2SWH
65-50-130	5.5	2 083.01	NES065-50-130 -5.5/2SWH
	4	1 910.55	NES065-50-130 -4/2SWH

Модель агрегата	Мощность, кВт	Цена розница USD с НДС	Артикул
80-65-130	11	2 921.95	NES080-65-130-11/2SWH
	7.5	2 198.27	NES080-65-130-7.5/2SWH
	5.5	2 148.54	NES080-65-130-5.5/2SWH
80-65-160	18.5	3 470.50	NES080-65-160-18.5/2SWH
	15	3 342.82	NES080-65-160-15/2SWH
	11	3 215.74	NES080-65-160-11/2SWH
	7.5	3 132.25	NES080-65-160-7.5/2SWH
80-65-200H	5.5	3 010.06	NES080-65-160-5.5/2SWH
	30	4 086.94	NES080-65-200H-30/2SWH
	22	3 617.71	NES080-65-200H-22/2SWH
	18.5	3 340.94	NES080-65-200H-18.5/2SWH
80-65-260	15	3 213.26	NES080-65-200H-15/2SWH
	55	6 090.00	NES080-65-260-55/2SWH
	45	5 422.36	NES080-65-260-45/2SWH
	37	4 746.98	NES080-65-260-37/2SWH
80-65-320H	30	4 534.36	NES080-65-260-30/2SWH
	90	9 130.52	NES080-65-320H-90/2SWH
	75	7 291.96	NES080-65-320H-75/2SWH
	55	6 611.10	NES080-65-320H-55/2SWH
100-80-160	45	6 274.43	NES080-65-320H-45/2SWH
	30	4 296.60	NES0100-80-160-30/2SWH
	22	3 827.37	NES0100-80-160-22/2SWH
	18.5	3 550.60	NES0100-80-160-18.5/2SWH
100-80-200	15	3 422.92	NES0100-80-160-15/2SWH
	11	3 404.19	NES0100-80-160-11/2SWH
	45	5 800.56	NES0100-80-200-45/2SWH
	37	4 647.49	NES0100-80-200-37/2SWH
100-80-260	30	4 434.87	NES0100-80-200-30/2SWH
	22	3 972.92	NES0100-80-200-22/2SWH
	75	7 973.30	NES0100-80-260-75/2SWH
	55	6 488.23	NES0100-80-260-55/2SWH
100-80-320H	45	6 018.12	NES0100-80-260-45/2SWH
	37	5 423.26	NES0100-80-260-37/2SWH
	132	13 750.72	NES0100-80-320H-132/2SWH
	110	13 042.33	NES0100-80-320H-110/2SWH
100-125-100-160-30/2SWH	90	8 681.63	NES0100-80-320H-90/2SWH
	75	7 393.46	NES0100-80-320H-75/2SWH
	30	4 424.55	NES0125-100-160-30/2SWH

100-80-160	3	2 279.16	NESO100-80-160-3/4SWH
	2.2	2 249.03	NESO100-80-160-2.2/4SWH
	1.5	2 186.55	NESO100-80-160-1.5/4SWH
100-80-200	7.5	3 196.02	NESO100-80-200-7.5/4SWH
	5.5	3 098.32	NESO100-80-200-5.5/4SWH
	4	2 912.27	NESO100-80-200-4/4SWH
100-80-260	3	2 843.97	NESO100-80-200-3/4SWH
	11	3 705.86	NESO100-80-260-11/4SWH
	7.5	3 388.38	NESO100-80-260-7.5/4SWH
100-80-320	5.5	3 315.88	NESO100-80-260-5.5/4SWH
	4	3 135.11	NESO100-80-260-4/4SWH
	18.5	4 339.49	NESO100-80-320-18.5/4SWH
100-80-400	15	4 079.30	NESO100-80-320-15/4SWH
	11	3 930.23	NESO100-80-320-11/4SWH
	7.5	3 648.56	NESO100-80-320-7.5/4SWH
100-80-400	30	5 824.77	NESO100-80-400-30/4SWH
	22	5 302.24	NESO100-80-400-22/4SWH
	18.5	5 169.90	NESO100-80-400-18.5/4SWH
	15	4 921.59	NESO100-80-400-15/4SWH

250-200-320	45	9 547.94	NESO250-200-320-45/4SWH
	37	9 225.51	NESO250-200-320-37/4SWH
	30	8 773.51	NESO250-200-320-30/4SWH
250-200-400	132	17 637.38	NESO250-200-400-132/4SWH
	110	16 984.29	NESO250-200-400-110/4SWH
	90	12 104.24	NESO250-200-400-90/4SWH
	75	11 568.90	NESO250-200-400-75/4SWH
	55	10 745.94	NESO250-200-400-55/4SWH
300-250-320	90	12 427.01	NESO300-250-320-90/4SWH
	75	11 893.08	NESO300-250-320-75/4SWH
	55	11 008.51	NESO300-250-320-55/4SWH
	45	10 592.78	NESO300-250-320-45/4SWH
	37	10 270.95	NESO300-250-320-37/4SWH
300-250-400	185	21 429.21	NESO300-250-400-185/4SWH
	160	20 128.20	NESO300-250-400-160/4SWH
	132	18 903.05	NESO300-250-400-132/4SWH
	110	18 006.41	NESO300-250-400-110/4SWH
	90	15 269.13	NESO300-250-400-90/4SWH
	75	14 734.26	NESO300-250-400-75/4SWH

Sku_id указан для стандартного исполнения: Материал корпуса - GG25; Материал колеса - GG25; Материал вала - SS420; Уплотнение - сальниковое; смазка - консистентная; Энергия - 3*380; частота - 50 Гц; Цвет - Чёрный 9005; Двигатели+рама+муфта; Обычная нагрузка

Насосные агрегаты комплектуются двигателями с классом защиты IP55 в стандартном исполнении (по цене агрегата с двигателем IP54)!!!

80-50-200	2.2	1 190.08	SMM80-50-200-2,2/4	150-125-400	75	по запросу	SMM150-125-400-75/4
	1.1	1 122.23	SMM80-50-200-1,1/4		55		SMM150-125-400-55/4
	1.5	1 147.39	SMM80-50-200-1,5/4		45		6 067.87
80-50-250	5.5	1 779.68	SMM80-50-250-5,5/4	37	5 782.93	SMM150-125-400-37/4	
	4	1 480.79	SMM80-50-250-4/4	45	10 501.19	SMM150-125-500-45/4	
	3	1 404.14	SMM80-50-250-3/4	55	по запросу	SMM150-125-500-55/4	
80-50-315	11	2 664.59	SMM80-50-315-11/4	75		SMM150-125-500-75/4	
	7.5	2 193.24	SMM80-50-315-7,5/4	90		SMM150-125-500-90/4	
	5.5	2 081.29	SMM80-50-315-5,5/4	110	SMM150-125-500-110/4		
80-65-160	2.2	1 158.84	SMM80-65-160-2,2/4	132	SMM150-125-500-132/4		
	1.5	1 418.41	SMM80-65-160-1,5/4	75	по запросу	SMM200-150-315-75/4	
	1.1	1 376.59	SMM80-65-160-1,1/4	55		SMM200-150-315-55/4	
7.5	1 893.68	SMM100-65-200-7,5/4	45	5 885.92		SMM200-150-315-45/4	
100-65-200	5.5	1 795.88	SMM100-65-200-5,5/4	37	5 600.97	SMM200-150-315-37/4	
	3	1 501.29	SMM100-65-200-3/4	30	4 977.31	SMM200-150-315-30/4	
	4	1 557.20	SMM100-65-200-4/4	110	по запросу	SMM200-150-400-110/4	
100-65-260	11	2 576.64	SMM100-65-260-11/4	90		SMM200-150-400-90/4	
	7.5	2 163.53	SMM100-65-260-7,5/4	75		SMM200-150-400-75/4	
	5.5	2 051.59	SMM100-65-260-5,5/4	55	SMM200-150-400-55/4		
100-65-315	18.5	3 468.03	SMM100-65-315-18,5/4	45	7 907.34	SMM200-150-400-45/4	
	15	2 987.50	SMM100-65-315-15/4	132	по запросу	SMM200-150-500-132/4	
	11	2 783.97	SMM100-65-315-11/4	160		SMM200-150-500-160/4	
30	5 446.79	SMM100-80-400-30/4	132	SMM200-150-500-132/4			
100-80-400	22	4 614.97	SMM100-80-400-22/4	110	по запросу	SMM200-150-500-110/4	
	18.5	4 408.63	SMM100-80-400-18,5/4	90		SMM200-150-500-90/4	
	11	2 458.89	SMM125-100-200-11/4	75		SMM200-150-500-75/4	
125-100-200	7.5	2 079.26	SMM125-100-200-7,5/4	30	5 691.86	SMM250-200-250-30/4	
	5.5	1 967.32	SMM125-100-200-5,5/4	22	5 007.51	SMM250-200-250-22/4	
	4	1 728.82	SMM125-100-200-4/4	18.5	4 870.13	SMM250-200-250-18,5/4	
125-100-250	15	2 893.12	SMM125-100-250-15/4	15	4 547.63	SMM250-200-250-15/4	
	11	2 689.59	SMM125-100-250-11/4	75	по запросу	SMM250-200-315-75/4	
250-200-315	55	7 673.34	SMM250-200-315-55/4	55		SMM250-200-315-55/4	
	45			7 673.34		SMM250-200-315-45/4	
	37			7 362.29	SMM250-200-315-37/4		
250-200-400	160	по запросу	SMM250-200-400-160/4	160	по запросу	SMM250-200-400-160/4	
	132		SMM250-200-400-132/4	132		SMM250-200-400-132/4	
	110		SMM250-200-400-110/4	110		SMM250-200-400-110/4	
	90		SMM250-200-400-90/4	90		SMM250-200-400-90/4	
	55		SMM250-200-400-55/4	55		SMM250-200-400-55/4	
	75		SMM250-200-400-75/4	75		SMM250-200-400-75/4	
250-200-500	132	по запросу	SMM250-200-500-132/4	160	по запросу	SMM250-200-500-160/4	
	160		SMM250-200-500-160/4	200		SMM250-200-500-200/4	
	200		SMM250-200-500-200/4	110		по запросу	SMM300-250-315-110/4
300-250-315	90	SMM300-250-315-90/4	90	SMM300-250-315-90/4			
	75	SMM300-250-315-75/4	75	SMM300-250-315-75/4			
	55	SMM300-250-315-55/4	55	SMM300-250-315-55/4			
	45	11 965.82	SMM300-250-315-45/4	45	SMM300-250-315-45/4		
	250	по запросу	SMM300-250-400-250/4	250	SMM300-250-400-250/4		
220	SMM300-250-400-220/4		220	SMM300-250-400-220/4			
200	SMM300-250-400-200/4		200	SMM300-250-400-200/4			
160	SMM300-250-400-160/4		160	SMM300-250-400-160/4			
132	SMM300-250-400-132/4		132	SMM300-250-400-132/4			
110	SMM300-250-400-110/4		110	SMM300-250-400-110/4			
90	SMM300-250-400-90/4		90	SMM300-250-400-90/4			
75	SMM300-250-400-75/4	75	SMM300-250-400-75/4				
350-300-400	90	по запросу	SMM350-300-400-90/4	90	по запросу	SMM350-300-400-90/4	
	110		SMM350-300-400-110/4	110		SMM350-300-400-110/4	
	132		SMM350-300-400-132/4	132		SMM350-300-400-132/4	
	160		SMM350-300-400-160/4	160		SMM350-300-400-160/4	
	200		SMM350-300-400-200/4	200		SMM350-300-400-200/4	
	220		SMM350-300-400-220/4	220		SMM350-300-400-220/4	
250	SMM350-300-400-250/4	250	SMM350-300-400-250/4				
350-300-500	90	по запросу	SMM350-300-500-90/4	90	по запросу	SMM350-300-500-90/4	
	110		SMM350-300-500-110/4	110		SMM350-300-500-110/4	
	132		SMM350-300-500-132/4	132		SMM350-300-500-132/4	
	160		SMM350-300-500-160/4	160		SMM350-300-500-160/4	
	200		SMM350-300-500-200/4	200		SMM350-300-500-200/4	
	220		SMM350-300-500-220/4	220		SMM350-300-500-220/4	
	250		SMM350-300-500-250/4	250		SMM350-300-500-250/4	
315	SMM350-300-500-315/4	315	SMM350-300-500-315/4				



NIS центробежные консольно-моноблочные насосы по стандарту DIN 24256

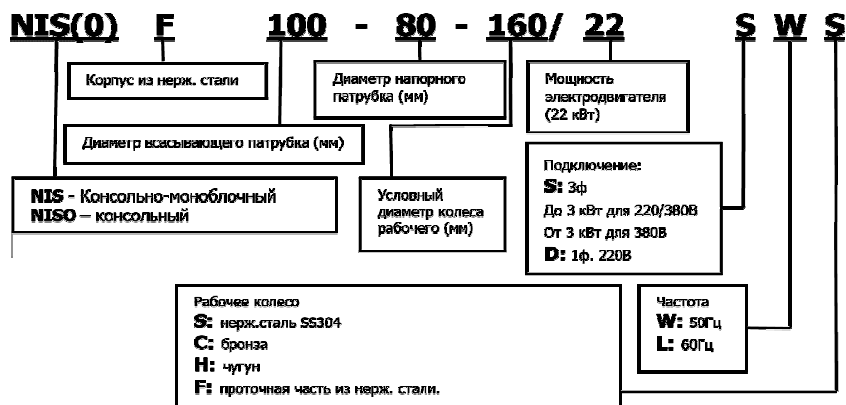

1. Цены в прайсе даны для насосов с двигателем 50Гц/ 380В

обновление 25.04.2021

2. Материал: корпус насоса выполнен из чугуна с шаровидным графитом, а остальные детали (рабочее колесо, крышка насоса и т. д.) выполнены из серого чугуна.

№ п/п	Модель/Артикул	Кол-во полюсов	Мощность (кВт)	Цена розница (USD) с НДС
1	NIS50-32-160/3SWH	2	3	1 097.87
2	NIS50-32-160/4SWH	2	4	1 243.36
3	NIS50-32-160/5.5SWH	2	5.5	1 544.68
4	NIS50-32-200/7.5SWH	2	7.5	1 653.70
5	NIS50-32-200/11SWH	2	11	2 171.56
6	NIS65-40-200/7.5SWH	2	7.5	1 672.94
7	NIS65-40-200/11SWH	2	11	2 202.73
8	NIS65-40-200/15SWH	2	15	2 348.81
9	NIS65-40-250/18.5SWH	2	18.5	2 618.25
10	NIS65-40-250/22SWH	2	22	3 087.28
11	NIS65-40-250/30SWH	2	30	4 074.40
12	NIS65-40-315/22SWH	2	22	3 299.29
13	NIS65-40-315/30SWH	2	30	4 227.66
14	NIS65-40-315/37SWH	2	37	4 551.01
15	NIS65-40-315/45SWH	2	45	5 673.91
16	NIS65-50-160/4SWH	2	4	1 266.23
17	NIS65-50-160/5.5SWH	2	5.5	1 567.49
18	NIS65-50-160/7.5SWH	2	7.5	1 603.42
19	NIS80-50-200/11SWH	2	11	2 219.43
20	NIS80-50-200/15SWH	2	15	2 365.47
21	NIS80-50-200/18.5SWH	2	18.5	2 489.15
22	NIS80-50-200/22SWH	2	22	3 004.29
23	NIS80-50-250/30SWH	2	30	4 103.73
24	NIS80-50-250/37SWH	2	37	4 427.11
25	NIS80-50-315/37SWH	2	37	4 622.57
26	NIS80-50-315/45SWH	2	45	5 687.30
27	NIS80-50-315/55SWH	2	55	по запросу
28	NIS80-50-315/75SWH	2	75	по запросу
29	NIS80-65-160/5.5SWH	2	5.5	1 611.70
30	NIS80-65-160/7.5SWH	2	7.5	1 647.63
31	NIS80-65-160/11SWH	2	11	2 177.68

32	NIS80-65-160/15SWH	2	15	2 323.75
33	NIS100-65-200/18.5SWH	2	18.5	2 639.72
34	NIS100-65-200/22SWH	2	22	3 157.58
35	NIS100-65-200/30SWH	2	30	4 093.55
36	NIS100-65-200/37SWH	2	37	4 416.91
37	NIS100-65-250/45SWH	2	45	5 670.83
38	NIS100-65-250/55SWH	2	55	по запросу
39	NIS100-65-250/75SWH	2	75	по запросу
40	NIS100-65-315/90SWH	2	90	по запросу
41	NIS100-65-315/110SWH	2	110	по запросу
175	NIS100-65-200G/18.5SWH	2	18.5	2 639.72
176	NIS100-65-200G/22SWH	2	22	3 157.58
177	NIS100-65-200G/30SWH	2	30	4 093.52
178	NIS100-65-200G/37SWH	2	37	4 416.93
179	NIS100-65-250G/45SWH	2	45	5 670.83
180	NIS100-65-250G/55SWH	2	55	по запросу
181	NIS100-65-315G/75SWH	2	75	по запросу
182	NIS100-65-315G/90SWH	2	90	по запросу
183	NIS100-80-160G/11SWH	2	11	2 359.46
184	NIS100-80-160G/15SWH	2	15	2 506.23
185	NIS100-80-160G/18.5SWH	2	18.5	2 625.88
42	NIS100-80-160/11SWH	2	11	2 359.46
43	NIS100-80-160/15SWH	2	15	2 506.23
44	NIS100-80-160/18.5SWH	2	18.5	2 625.91
45	NIS100-80-160/22SWH	2	22	3 135.91
46	NIS125-100-200/30SWH	2	30	4 303.80
47	NIS125-100-200/37SWH	2	37	4 627.18
48	NIS125-100-200/45SWH	2	45	5 662.58
49	NIS125-100-200/55SWH	2	55	по запросу
50	NIS125-100-200/75SWH	2	75	по запросу
51	NIS125-100-250/75SWH	2	75	по запросу
52	NIS125-100-250/90SWH	2	90	по запросу
53	NIS125-100-250/110SWH	2	110	по запросу
54	NIS125-100-315/90SWH	2	90	по запросу
55	NIS125-100-315/110SWH	2	110	по запросу
56	NIS125-100-315/132SWH	2	132	по запросу
57	NIS125-100-315/160SWH	2	160	по запросу
186	NIS125-100-200G/30SWH	2	30	4 303.80
187	NIS125-100-200G/37SWH	2	37	4 627.18
188	NIS125-100-200G/45SWH	2	45	5 662.58
189	NIS125-100-200G/55SWH	2	55	по запросу
190	NIS125-100-200G/75SWH	2	75	по запросу
191	NIS125-100-250G/75SWH	2	75	по запросу
192	NIS125-100-250G/90SWH	2	90	по запросу
193	NIS125-100-315G/110SWH	2	110	по запросу
194	NIS125-100-315G/132SWH	2	132	по запросу
195	NIS125-100-315G/160SWH	2	160	по запросу
58	NIS125-80-400/15SWH	2	15	3 408.06
59	NIS125-80-400/18.5SWH	2	18.5	3 866.50
60	NIS125-80-400/22SWH	2	22	4 094.00
61	NIS125-80-400/30SWH	2	30	5 065.32
62	NIS125-80-400/37SWH	2	37	5 540.45
63	NIS125-100-400/30SWH	2	30	5 108.57
64	NIS125-100-400/37SWH	2	37	5 629.25
65	NIS125-100-400/45SWH	2	45	6 610.92
66	NIS150-125-250/22SWH	4	22	3 847.40
67	NIS150-125-250/18.5SWH	4	18.5	3 660.73
68	NIS150-125-250/15SWH	4	15	3 190.04
69	NIS150-125-250/11SWH	4	11	3 021.35
70	NIS150-125-315/37SWH	4	37	5 654.42
71	NIS150-125-315/30SWH	4	30	5 133.94
72	NIS150-125-400/75SWH	4	75	по запросу
73	NIS150-125-400/55SWH	4	55	по запросу

199	NIS150-125-200G/5.5SWH	4	5.5	2 443.85
200	NIS150-125-200G/7.5SWH	4	7.5	2 515.55
201	NIS150-125-200G/11SWH	4	11	3 019.90
202	NIS150-125-250G/11SWH	4	11	3 021.35
203	NIS150-125-250G/15SWH	4	15	3 190.07
204	NIS150-125-250G/18.5SWH	4	18.5	3 660.76
205	NIS150-125-315G/30SWH	4	30	5 133.94
206	NIS150-125-315G/37SWH	4	37	5 654.42
207	NIS150-125-400G/45SWH	4	45	6 794.18
208	NIS150-125-400G/55SWH	4	55	по запросу
209	NIS150-125-400G/75SWH	4	75	по запросу
74	NIS150-125-400/45SWH	4	45	6 794.21
220	NIS150-125-250G/22SWH	4	22	3 847.40
75	NIS200-150-315/75SWH	4	75	по запросу
76	NIS200-150-315/55SWH	4	55	по запросу
77	NIS200-150-315/45SWH	4	45	6 964.16
78	NIS200-150-315/37SWH	4	37	5 991.25
79	NIS200-150-400/110SWH	4	110	по запросу
80	NIS200-150-400/90SWH	4	90	по запросу
81	NIS200-150-400/75SWH	4	75	по запросу
210	NIS200-150-250G/15SWH	4	15	3 606.29
211	NIS200-150-250G/18.5SWH	4	18.5	4 226.04
212	NIS200-150-250G/22SWH	4	22	4 431.11
213	NIS200-150-250G/30SWH	4	30	5 511.09
214	NIS200-150-315G/37SWH	4	37	5 991.22
215	NIS200-150-315G/45SWH	4	45	6 964.16
216	NIS200-150-315G/55SWH	4	55	по запросу
217	NIS200-150-400G/75SWH	4	75	по запросу
218	NIS200-150-400G/90SWH	4	90	по запросу
219	NIS200-150-400G/110SWH	4	110	по запросу
82	NIS250-200-250/22SWH		22	5 603.84
83	NIS250-200-250/30SWH		30	6 633.84
84	NIS250-200-250/37SWH		37	6 851.64
85	NIS250-200-250/45SWH		45	8 003.42
86	NIS250-200-315/37SWH	4	37	6 289.55
87	NIS250-200-315/45SWH	4	45	7 262.46
88	NIS250-200-315/55SWH	4	55	по запросу
89	NIS250-200-315/75SWH	4	75	по запросу
90	NIS250-200-400/90SWH	4	90	по запросу
91	NIS250-200-400/110SWH	4	110	по запросу
92	NIS250-200-400/132SWH	4	132	по запросу
93	NIS250-200-400/160SWH	4	160	по запросу
94	NIS50-32-160/0.55SWH	4	0.55	841.43
95	NIS50-32-160/0.75SWH	4	0.75	850.60
96	NIS50-32-200/1.1SWH	4	1.1	1 001.71
97	NIS50-32-200/1.5SWH	4	1.5	1 045.47
98	NIS65-40-200/1.1SWH	4	1.1	1 005.21
99	NIS65-40-200/1.5SWH	4	1.5	1 048.55
100	NIS65-40-200/2.2SWH	4	2.2	1 179.69
101	NIS65-40-250/3SWH	4	3	1 338.15
102	NIS65-40-315/4SWH	4	4	1 677.16
103	NIS65-40-315/5.5SWH	4	5.5	2 085.97
104	NIS65-50-160/0.55SWH	4	0.55	864.64
105	NIS65-50-160/0.75SWH	4	0.75	873.11
106	NIS65-50-160/1.1SWH	4	1.1	956.16
107	NIS80-50-200/1.5SWH	4	1.5	1 074.05
108	NIS80-50-200/2.2SWH	4	2.2	1 205.97
109	NIS80-50-200/3SWH	4	3	1 251.27
110	NIS80-50-250/4SWH	4	4	1 511.54
111	NIS80-50-250/5.5SWH	4	5.5	1 928.90
112	NIS80-50-315/5.5SWH	4	5.5	2 140.99
113	NIS80-50-315/7.5SWH	4	7.5	2 208.05
114	NIS80-65-160/0.75SWH	4	0.75	901.86

115	NIS80-65-160/1.1SWH	4	1.1	988.09
116	NIS80-65-160/1.5SWH	4	1.5	1 031.41
117	NIS100-65-200/3SWH	4	3	1 390.80
118	NIS100-65-200/4SWH	4	4	1 520.83
119	NIS100-65-200/5.5SWH	4	5.5	1 939.25
120	NIS100-65-250/5.5SWH	4	5.5	2 081.46
121	NIS100-65-250/7.5SWH	4	7.5	2 150.33
122	NIS100-65-315/11SWH	4	11	2 852.80
123	NIS100-65-315/15SWH	4	15	3 010.08
124	NIS100-80-160/1.5SWH	4	1.5	1 159.28
125	NIS100-80-160/2.2SWH	4	2.2	1 280.24
126	NIS100-80-160/3SWH	4	3	1 325.54
161	NIS100-65-200G/3SWH	4	3	1 390.80
162	NIS100-65-200G/4SWH	4	4	1 520.83
163	NIS100-65-250G/5.5SWH	4	5.5	2 081.46
164	NIS100-65-250G/7.5SWH	4	7.5	2 150.33
165	NIS100-65-315G/11SWH	4	11	2 852.80
166	NIS100-65-315G/15SWH	4	15	3 010.08
167	NIS100-80-160G/1.5SWH	4	1.5	1 159.28
168	NIS100-80-160G/2.2SWH	4	2.2	1 280.24
127	NIS125-100-200/4SWH	4	4	1 642.88
128	NIS125-100-200/5.5SWH	4	5.5	2 071.31
129	NIS125-100-200/7.5SWH	4	7.5	2 137.30
130	NIS125-100-200/11SWH	4	11	2 570.99
131	NIS125-100-250/15SWH	4	15	3 065.22
132	NIS125-100-315/11SWH	4	11	3 047.41
133	NIS125-100-315/18.5SWH	4	18.5	3 675.24
134	NIS125-100-315/22SWH	4	22	3 889.65
135	NIS125-100-315/30SWH	4	30	4 777.14
169	NIS125-100-200G/4SWH	4	4	1 642.88
170	NIS125-100-200G/5.5SWH	4	5.5	2 071.31
171	NIS125-100-200G/7.5SWH	4	7.5	2 137.30
172	NIS125-100-250G/11SWH	4	11	по запросу
173	NIS125-100-315G/15SWH	4	15	по запросу
174	NIS125-100-315G/18.5SWH	4	18.5	3 675.24
196	NIS125-100-400G/30SWH	4	30	5 108.55
197	NIS125-100-400G/37SWH	4	37	5 629.25
198	NIS125-100-400G/45SWH	4	45	6 610.92
136	NIS300-250-315(Q)/75SWH	4	75	по запросу
137	NIS300-250-315(Q)/90SWH	4	90	по запросу
138	NIS300-250-315(Q)/110SWH	4	110	по запросу
139	NIS300-250-400/132SWH	4	132	по запросу
140	NIS300-250-400/160SWH	4	160	по запросу
141	NIS300-250-400/200SWH	4	200	по запросу
142	NIS300-250-315/75SWH	4	75	по запросу
143	NIS300-250-315/90SWH	4	90	по запросу
144	NIS300-250-315/110SWH	4	110	по запросу
145	NIS300-250-400(Q)/110SWH	4	110	по запросу
146	NIS300-250-400(Q)/132SWH	4	132	по запросу
147	NIS300-250-400(Q)/160SWH	4	160	по запросу
148	NIS300-250-400(Q)/200SWH	4	200	по запросу
149	NIS150-125-400(Q)/37SWH	4	37	6 900.35
150	NIS150-125-315(Q)/30SWH	4	30	5 960.27
151	NIS150-125-315(Q)/22SWH	4	22	4 903.05
152	NIS200-150-250(Q)/11SWH	4	11	3 990.37
153	NIS200-150-250(Q)/15SWH	4	15	4 185.16
154	NIS200-150-250(Q)/18.5SWH	4	18.5	4 906.10
155	NIS200-150-250(Q)/22SWH	4	22	5 142.72
156	NIS125-100-200(Q)/30SWH	4	30	4 996.64
157	NIS125-100-200(Q)/37SWH	4	37	5 371.75
158	NIS150-125-200(Q)/5.5SWH	4	5.5	2 836.16
159	NIS150-125-200(Q)/7.5SWH	4	7.5	2 919.46
160	NIS150-125-200(Q)/11SWH	4	11	3 504.95

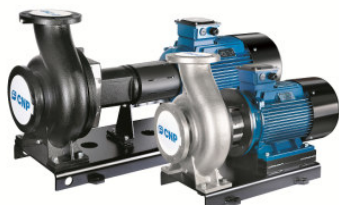

NISF центробежные консольно-моноблочные насосы из нерж. стали

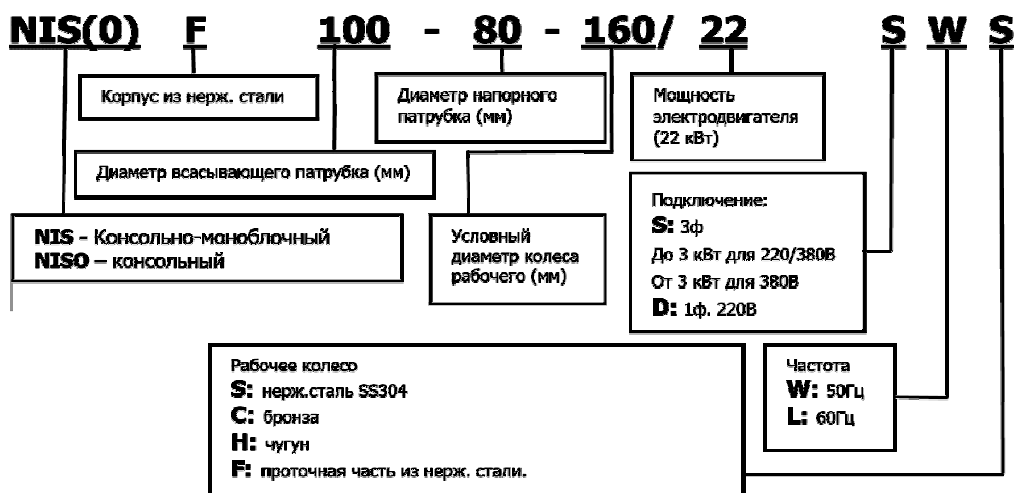

обновление 25.04.2022

№ п/п	Модель/Артикул	Кол-во полюсов	Мощность (кВт)	Цена розница (USD) с НДС
1	NISF50-32-160/3SWF	2	3	1 809.12
2	NISF50-32-160/4SWF	2	4	1 969.21
3	NISF50-32-160/5.5SWF	2	5.5	2 328.59
4	NISF50-32-200/7.5SWF	2	7.5	2 838.50
5	NISF50-32-200/11SWF	2	11	3 494.54
6	NISF50-32-160/0.55SWF	4	0.55	1 522.54
7	NISF50-32-200/1.5SWF	4	1.5	2 121.44
8	NISF50-32-160/0.75SWF	4	0.75	1 529.81
11	NISF65-40-200/11SWF	2	11	3 583.52
12	NISF65-40-200/15SWF	2	15	3 768.79
13	NISF65-40-315/22SWF	2	22	5 948.47
14	NISF65-40-315/30SWF	2	30	7 111.10
15	NISF65-40-315/37SWF	2	37	7 495.66
16	NISF65-40-315/45SWF	2	45	8 855.27
17	NISF65-40-250/18.5SWF	2	18.5	4 752.84
18	NISF65-40-250/22SWF	2	22	5 343.93
19	NISF65-40-250/30SWF	2	30	6 517.74
20	NISF65-40-250/3SWF	4	3	3 159.82
21	NISF65-40-200/1.5SWF	4	1.5	2 214.94

22	NISF65-40-200/1.1SWF	4	1.1	2 163.42
23	NISF65-40-200/2.2SWF	4	2.2	2 344.23
24	NISF65-40-315/4SWF	4	4	3 942.91
25	NISF65-40-315/5.5SWF	4	5.5	4 465.70
26	NISF65-50-160/4SWF	2	4	2 059.90
27	NISF65-50-160/5.5SWF	2	5.5	2 423.71
28	NISF65-50-160/7.5SWF	2	7.5	2 467.37
29	NISF65-50-160/1.1SWF	4	1.1	1 712.84
30	NISF65-50-160/0.55SWF	4	0.55	1 622.18
31	NISF65-50-160/0.75SWF	4	0.75	1 625.52
32	NISF80-50-200/11SWF	2	11	3 719.00
33	NISF80-50-200/15SWF	2	15	3 904.81
34	NISF80-50-200/18.5SWF	2	18.5	4 059.91
35	NISF80-50-200/22SWF	2	22	4 781.40
36	NISF80-50-315/37SWF	2	37	7 813.57
37	NISF80-50-315/45SWF	2	45	9 155.30
38	NISF80-50-315/55SWF	2	55	по запросу
39	NISF80-50-315/75SWF	2	75	
40	NISF80-50-250/30SWF	2	30	6 422.02
41	NISF80-50-250/37SWF	2	37	6 814.98
42	NISF80-50-200/1.5SWF	4	1.5	2 350.96
43	NISF80-50-200/3SWF	4	3	2 536.23
44	NISF80-50-315/7.5SWF	4	7.5	4 861.44
45	NISF80-50-200/2.2SWF	4	2.2	2 480.25
46	NISF80-50-315/5.5SWF	4	5.5	4 783.07
47	NISF80-50-250/5.5SWF	4	5.5	3 764.90
48	NISF80-50-250/4SWF	4	4	3 248.24
49	NISF80-65-160/1.5SWF	4	1.5	1 868.47
50	NISF80-65-160/5.5SWF	2	5.5	2 546.87
51	NISF80-65-160/7.5SWF	2	7.5	2 575.43
52	NISF80-65-160/11SWF	2	11	3 249.91
53	NISF80-65-160/15SWF	2	15	3 435.75
54	NISF80-65-160/1.1SWF	4	1.1	1 818.09
55	NISF80-65-160/0.75SWF	4	0.75	1 734.13
56	NISF100-65-200/5.5SWF	4	5.5	3 810.23
57	NISF100-65-200/18.5SWF	2	18.5	4 685.12
58	NISF100-65-200/22SWF	2	22	5 276.23
59	NISF100-65-200/30SWF	2	30	6 448.33
60	NISF100-65-200/37SWF	2	37	6 841.30
61	NISF100-65-315/110SWF	2	110	по запросу
62	NISF100-65-315/90SWF	2	90	
63	NISF100-65-250/45SWF	2	45	8 751.15
64	NISF100-65-250/55SWF	2	55	по запросу
65	NISF100-65-250/75SWF	2	75	
66	NISF100-65-250/7.5SWF	4	7.5	4 426.53
67	NISF100-65-315/11SWF	4	11	5 959.69
68	NISF100-65-200/3SWF	4	3	3 089.28
69	NISF100-65-315/15SWF	4	15	6 156.17

70	NISF100-65-200/4SWF	4	4	3 275.09
71	NISF100-65-250/5.5SWF	4	5.5	4 341.43
72	NISF100-80-160/1.5SWF	4	1.5	2 163.42
73	NISF100-80-160/2.2SWF	4	2.2	2 307.30
74	NISF100-80-160/3SWF	4	3	2 362.71
75	NISF100-80-160/11SWF	2	11	3 614.32
76	NISF100-80-160/15SWF	2	15	3 800.69
77	NISF100-80-160/18.5SWF	2	18.5	3 937.85
78	NISF100-80-160/22SWF	2	22	4 543.53
79	NISF125-80-400/15SWF	4	15	8 076.10
80	NISF125-80-400/18.5SWF	4	18.5	8 659.92
81	NISF125-80-400/22SWF	4	22	8 895.04
82	NISF125-80-400/30SWF	4	30	10 066.00
83	NISF125-80-400/37SWF	4	37	10 590.53
84	NISF125-100-200/5.5SWF	4	5.5	4 390.71
85	NISF125-100-200/7.5SWF	4	7.5	4 471.86
86	NISF125-100-200/11SWF	4	11	5 022.67
87	NISF125-100-200/30SWF	2	30	6 991.28
88	NISF125-100-200/37SWF	2	37	7 384.81
89	NISF125-100-200/45SWF	2	45	8 802.67
90	NISF125-100-200/55SWF	2	55	по запросу
91	NISF125-100-200/75SWF	2	75	
92	NISF125-100-250/90SWF	2	90	
93	NISF125-100-315/110SWF	2	110	
94	NISF125-100-315/132SWF	2	132	
95	NISF125-100-315/160SWF	2	160	
96	NISF125-100-315/22SWF	4	22	7 818.62
97	NISF125-100-315/30SWF	4	30	9 024.87
98	NISF125-100-315/90SWF	2	90	по запросу
99	NISF125-100-400/30SWF	4	30	10 436.57
100	NISF125-100-400/37SWF	4	37	11 139.64
101	NISF125-100-400/45SWF	4	45	12 307.82
102	NISF125-100-250/75SWF	2	75	по запросу
103	NISF125-100-250/110SWF	2	110	
104	NISF125-100-250/15SWF	4	15	6 398.52
105	NISF125-100-315/18.5SWF	4	18.5	7 595.29
106	NISF125-100-315/11SWF	4	11	6 796.51
107	NISF125-100-200/4SWF	4	4	3 849.40
108	NISF150-125-315/30SWF	4	30	9 558.88
109	NISF150-125-315/37SWF	4	37	10 252.41
110	NISF150-125-400/45SWF	4	45	12 595.56
111	NISF150-125-250/18.5SWF	4	18.5	7 327.73
112	NISF150-125-250/22SWF	4	22	7 539.85
113	NISF150-125-250/11SWF	4	11	6 516.06
114	NISF150-125-250/15SWF	4	15	6 766.28
115	NISF150-125-400/55SWF	4	55	по запросу
116	NISF150-125-400/75SWF	4	75	
117	NISF200-150-315/37SWF	4	37	11 867.86

118	NISF200-150-315/45SWF	4	45	13 047.28
119	NISF200-150-315/55SWF	4	55	по запросу
120	NISF200-150-315/75SWF	4	75	
121	NISF200-150-250/30SWF	4	30	9 354.02
122	NISF200-150-400/75SWF	4	75	по запросу
123	NISF200-150-400/90SWF	4	90	
124	NISF200-150-400/110SWF	4	110	
125	NISF250-200-315/37SWF	4	37	12 975.07
126	NISF250-200-315/45SWF	4	45	14 154.47
127	NISF250-200-315/55SWF	4	55	по запросу
128	NISF250-200-315/75SWF	4	75	
129	NISF250-200-400/90SWF	4	90	
130	NISF250-200-400/110SWF	4	110	
131	NISF250-200-400/160SWF	4	160	по запросу
132	NISF250-200-400/132SWF	4	132	
133	NISF300-250-400(Q)/110SWF	4	110	
134	NISF300-250-400(Q)/132SWF	4	132	
135	NISF300-250-400(Q)/160SWF	4	160	
136	NISF300-250-400(Q)/200SWF	4	200	
137	NISF300-250-400/132SWF	4	132	
138	NISF300-250-400/160SWF	4	160	
139	NISF300-250-400/200SWF	4	200	
140	NISF300-250-315(Q)/75SWF	4	75	
141	NISF300-250-315(Q)/90SWF	4	90	
142	NISF300-250-315(Q)/110SWF	4	110	
143	NISF300-250-315/75SWF	4	75	
144	NISF300-250-315/90SWF	4	90	
145	NISF300-250-315/110SWF	4	110	



NISO центробежные консольные насосы

обновление
25.04.2022

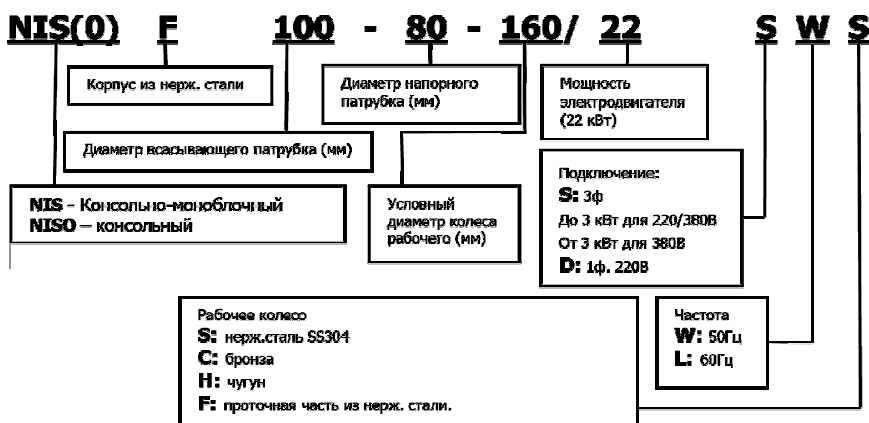

Проточн. часть - чугун НТ200, рабочее колесо- чугун НТ200		Проточн. часть - чугун НТ200, рабочее колесо- нержавеющая сталь 304		Проточн. часть - ковкий чугун, рабочее колесо- чугун НТ200		Мощность, кВт
Артикул	Цена розница (USD) с НДС	Артикул	Цена розница (USD) с НДС	Артикул	Цена розница (USD) с НДС	
2-х полюсной электродвигатель						
NISO50-32-160/3SWH	1 237.86	NISO50-32-160/3SWS	1 429.63	NISO50-32-160/3SWH DI	1 327.43	3
NISO50-32-160/4SWH	1 364.06	NISO50-32-160/4SWS	1 562.69	NISO50-32-160/4SWH DI	1 461.98	4
NISO50-32-160/5.5SWH	1 650.43	NISO50-32-160/5.5SWS	1 866.02	NISO50-32-160/5.5SWH DI	1 769.03	5.5
NISO50-32-200/7.5SWH	1 778.27	NISO50-32-200/7.5SWS	2 054.61	NISO50-32-200/7.5SWH DI	1 906.20	7.5
NISO50-32-200/11SWH	2 175.79	NISO50-32-200/11SWS	2 475.80	NISO50-32-200/11SWH DI	2 332.22	11
NISO65-40-200/7.5SWH	1 778.98	NISO65-40-200/7.5SWS	2 022.64	NISO65-40-200/7.5SWH DI	1 907.23	7.5
NISO65-40-200/11SWH	2 192.65	NISO65-40-200/11SWS	2 461.15	NISO65-40-200/11SWH DI	2 350.90	11
NISO65-40-200/15SWH	2 326.27	NISO65-40-200/15SWS	2 602.58	NISO65-40-200/15SWH DI	2 493.80	15
NISO65-40-250/18.5SWH	2 704.21	NISO65-40-250/18.5SWS	3 103.42	NISO65-40-250/18.5SWH DI	2 898.52	18.5
NISO65-40-250/22SWH	3 108.24	NISO65-40-250/22SWS	3 531.92	NISO65-40-250/22SWH DI	3 332.31	22
NISO65-40-250/30SWH	3 901.48	NISO65-40-250/30SWS	4 372.72	NISO65-40-250/30SWH DI	4 182.80	30
NISO65-40-315/22SWH	3 262.46	NISO65-40-315/22SWS	4 226.72	NISO65-40-315/22SWH DI	3 497.55	22
NISO65-40-315/30SWH	4 020.02	NISO65-40-315/30SWS	5 088.71	NISO65-40-315/30SWH DI	4 309.58	30
NISO65-40-315/37SWH	4 321.96	NISO65-40-315/37SWS	5 432.50	NISO65-40-315/37SWH DI	4 633.26	37
NISO65-40-315/45SWH	5 204.85	NISO65-40-315/45SWS	6 437.39	NISO65-40-315/45SWH DI	5 579.84	45
NISO65-50-160/4SWH	1 381.60	NISO65-50-160/4SWS	1 580.52	NISO65-50-160/4SWH DI	1 481.21	4
NISO65-50-160/5.5SWH	1 668.13	NISO65-50-160/5.5SWS	1 884.38	NISO65-50-160/5.5SWH DI	1 788.78	5.5
NISO65-50-160/7.5SWH	1 700.87	NISO65-50-160/7.5SWS	1 918.94	NISO65-50-160/7.5SWH DI	1 823.58	7.5
NISO80-50-200/11SWH	2 230.81	NISO80-50-200/11SWS	2 497.81	NISO80-50-200/11SWH DI	2 390.92	11
NISO80-50-200/15SWH	2 364.40	NISO80-50-200/15SWS	2 639.78	NISO80-50-200/15SWH DI	2 534.82	15
NISO80-50-200/18.5SWH	2 502.50	NISO80-50-200/18.5SWS	2 785.92	NISO80-50-200/18.5SWH DI	2 682.39	18.5
NISO80-50-200/22SWH	2 907.14	NISO80-50-200/22SWS	3 214.97	NISO80-50-200/22SWH DI	3 116.73	22
NISO80-50-250/30SWH	3 965.52	NISO80-50-250/30SWS	4 396.32	NISO80-50-250/30SWH DI	4 250.88	30

NISO80-50-250/37SWH	4 267.47	NISO80-50-250/37SWS	4 715.88	NISO80-50-250/37SWH DI	4 574.54	37
NISO80-50-315/37SWH	4 407.99	NISO80-50-315/37SWS	5 543.35	NISO80-50-315/37SWH DI	4 724.69	37
NISO80-50-315/45SWH	5 282.86	NISO80-50-315/45SWS	6 539.81	NISO80-50-315/45SWH DI	5 663.50	45
NISO80-50-315/55SWH	6 170.80	NISO80-50-315/55SWS	7 550.36	NISO80-50-315/55SWH DI	6 615.29	55
NISO80-50-315/75SWH	7 672.03	NISO80-50-315/75SWS	9 259.16	NISO80-50-315/75SWH DI	8 224.31	75
NISO80-65-160/5.5SWH	1 745.65	NISO80-65-160/5.5SWS	1 936.20	NISO80-65-160/5.5SWH DI	1 871.91	5.5
NISO80-65-160/7.5SWH	1 778.41	NISO80-65-160/7.5SWS	1 970.27	NISO80-65-160/7.5SWH DI	1 906.20	7.5
NISO80-65-160/11SWH	2 193.49	NISO80-65-160/11SWS	2 410.83	NISO80-65-160/11SWH DI	2 351.97	11
NISO80-65-160/15SWH	2 327.12	NISO80-65-160/15SWS	2 552.31	NISO80-65-160/15SWH DI	2 494.84	15
NISO100-65-200/18.5SWH	2 803.76	NISO100-65-200/18.5SWS	3 133.80	NISO100-65-200/18.5SWH DI	3 005.52	18.5
NISO100-65-200/22SWH	3 209.08	NISO100-65-200/22SWS	3 563.37	NISO100-65-200/22SWH DI	3 440.38	22
NISO100-65-200/30SWH	4 006.93	NISO100-65-200/30SWS	4 408.37	NISO100-65-200/30SWH DI	4 295.04	30
NISO100-65-200/37SWH	4 308.87	NISO100-65-200/37SWS	4 728.95	NISO100-65-200/37SWH DI	4 619.21	37
NISO100-65-250/45SWH	5 402.82	NISO100-65-250/45SWS	6 007.20	NISO100-65-250/45SWH DI	5 792.35	45
NISO100-65-250/55SWH	6 224.07	NISO100-65-250/55SWS	6 877.35	NISO100-65-250/55SWH DI	6 672.46	55
NISO100-65-250/75SWH	7 738.29	NISO100-65-250/75SWS	8 481.96	NISO100-65-250/75SWH DI	8 295.48	75
NISO100-65-315/90SWH	8 669.86	NISO100-65-315/90SWS	9 311.26	NISO100-65-315/90SWH DI	9 294.04	90
NISO100-65-315/110SWH	13 478.32	NISO100-65-315/110SWS	14 407.44	NISO100-65-315/110SWH DI	14 448.90	110
NISO100-80-160/11SWH	2 402.56	NISO100-80-160/11SWS	2 650.77	NISO100-80-160/11SWH DI	2 575.36	11
NISO100-80-160/15SWH	2 536.19	NISO100-80-160/15SWS	2 792.20	NISO100-80-160/15SWH DI	2 718.74	15
NISO100-80-160/18.5SWH	2 666.87	NISO100-80-160/18.5SWS	2 931.03	NISO100-80-160/18.5SWH DI	2 859.02	18.5
NISO100-80-160/22SWH	3 092.18	NISO100-80-160/22SWS	3 381.57	NISO100-80-160/22SWH DI	3 314.67	22
NISO125-100-200/30SWH	4 133.95	NISO125-100-200/30SWS	4 568.65	NISO125-100-200/30SWH DI	4 431.15	30
NISO125-100-200/37SWH	4 435.92	NISO125-100-200/37SWS	4 889.27	NISO125-100-200/37SWH DI	4 755.35	37
NISO125-100-200/45SWH	5 413.54	NISO125-100-200/45SWS	5 924.96	NISO125-100-200/45SWH DI	5 803.26	45
NISO125-100-200/55SWH	6 234.79	NISO125-100-200/55SWS	6 795.12	NISO125-100-200/55SWH DI	6 683.37	55
NISO125-100-200/75SWH	7 749.01	NISO125-100-200/75SWS	8 399.73	NISO125-100-200/75SWH DI	8 306.91	75
NISO125-100-250/75SWH	8 176.20	NISO125-100-250/75SWS	8 974.40	NISO125-100-250/75SWH DI	8 765.14	75
NISO125-100-250/90SWH	8 702.87	NISO125-100-250/90SWS	9 532.33	NISO125-100-250/90SWH DI	9 329.37	90
NISO125-100-250/110SWH	13 511.32	NISO125-100-250/110SWS	14 628.51	NISO125-100-250/110SWH DI	14 484.77	110
NISO125-100-315/90SWH	8 769.80	NISO125-100-315/90SWS	9 672.71	NISO125-100-315/90SWH DI	9 401.08	90
NISO125-100-315/110SWH	13 578.29	NISO125-100-315/110SWS	14 768.90	NISO125-100-315/110SWH DI	14 555.93	110
NISO125-100-315/132SWH	14 330.44	NISO125-100-315/132SWS	15 565.71	NISO125-100-315/132SWH DI	15 362.26	132
NISO125-100-315/160SWH	15 145.01	NISO125-100-315/160SWS	16 429.04	NISO125-100-315/160SWH DI	16 235.60	160
4-х полюсной электродвигатель						
NISO50-32-160/0.55SWH	1 028.79	NISO50-32-160/0.55SWS	1 207.53	NISO50-32-160/0.55SWH DI	1 102.98	0.55
NISO50-32-160/0.75SWH	1 035.34	NISO50-32-160/0.75SWS	1 214.32	NISO50-32-160/0.75SWH DI	1 109.74	0.75
NISO50-32-200/1.1SWH	1 170.13	NISO50-32-200/1.1SWS	1 410.24	NISO50-32-200/1.1SWH DI	1 254.17	1.1
NISO50-32-200/1.5SWH	1 216.20	NISO50-32-200/1.5SWS	1 458.98	NISO50-32-200/1.5SWH DI	1 303.51	1.5
NISO65-40-200/1.1SWH	1 177.28	NISO65-40-200/1.1SWS	1 384.60	NISO65-40-200/1.1SWH DI	1 261.97	1.1
NISO65-40-200/1.5SWH	1 227.55	NISO65-40-200/1.5SWS	1 438.04	NISO65-40-200/1.5SWH DI	1 316.00	1.5
NISO65-40-200/2.2SWH	1 320.53	NISO65-40-200/2.2SWS	1 536.50	NISO65-40-200/2.2SWH DI	1 415.23	2.2
NISO65-40-250/3SWH	1 627.11	NISO65-40-250/3SWS	1 962.41	NISO65-40-250/3SWH DI	1 744.62	3
NISO65-40-315/4SWH	1 939.07	NISO65-40-315/4SWS	2 720.46	NISO65-40-315/4SWH DI	2 078.69	4
NISO65-40-315/5.5SWH	2 230.18	NISO65-40-315/5.5SWS	3 051.32	NISO65-40-315/5.5SWH DI	2 390.40	5.5
NISO65-50-160/0.55SWH	1 046.14	NISO65-50-160/0.55SWS	1 224.79	NISO65-50-160/0.55SWH DI	1 121.17	0.55
NISO65-50-160/0.75SWH	1 055.90	NISO65-50-160/0.75SWS	1 235.27	NISO65-50-160/0.75SWH DI	1 132.08	0.75
NISO65-50-160/1.1SWH	1 126.00	NISO65-50-160/1.1SWS	1 309.68	NISO65-50-160/1.1SWH DI	1 207.42	1.1
NISO80-50-200/1.5SWH	1 272.91	NISO80-50-200/1.5SWS	1 483.07	NISO80-50-200/1.5SWH DI	1 364.83	1.5
NISO80-50-200/2.2SWH	1 366.16	NISO80-50-200/2.2SWS	1 582.08	NISO80-50-200/2.2SWH DI	1 464.58	2.2
NISO80-50-200/3SWH	1 420.25	NISO80-50-200/3SWS	1 639.17	NISO80-50-200/3SWH DI	1 522.26	3
NISO80-50-250/4SWH	1 814.63	NISO80-50-250/4SWS	2 057.25	NISO80-50-250/4SWH DI	1 945.15	4
NISO80-50-250/5.5SWH	2 148.90	NISO80-50-250/5.5SWS	2 411.37	NISO80-50-250/5.5SWH DI	2 303.63	5.5
NISO80-50-315/5.5SWH	2 351.18	NISO80-50-315/5.5SWS	3 202.67	NISO80-50-315/5.5SWH DI	2 520.29	5.5
NISO80-50-315/7.5SWH	2 421.30	NISO80-50-315/7.5SWS	3 282.56	NISO80-50-315/7.5SWH DI	2 595.62	7.5
NISO80-65-160/0.75SWH	1 110.59	NISO80-65-160/0.75SWS	1 262.52	NISO80-65-160/0.75SWH DI	1 190.26	0.75
NISO80-65-160/1.1SWH	1 183.36	NISO80-65-160/1.1SWS	1 340.03	NISO80-65-160/1.1SWH DI	1 268.71	1.1
NISO80-65-160/1.5SWH	1 233.88	NISO80-65-160/1.5SWS	1 393.47	NISO80-65-160/1.5SWH DI	1 322.74	1.5

NISO100-65-200/3SWH	1 719.71	NISO100-65-200/3SWS	1 984.94	NISO100-65-200/3SWH DI	1 843.85	3
NISO100-65-200/4SWH	1 866.16	NISO100-65-200/4SWS	2 140.01	NISO100-65-200/4SWH DI	2 000.74	4
NISO100-65-200/5.5SWH	2 201.62	NISO100-65-200/5.5SWS	2 495.71	NISO100-65-200/5.5SWH DI	2 360.26	5.5
NISO100-65-250/5.5SWH	2 298.83	NISO100-65-250/5.5SWS	2 717.33	NISO100-65-250/5.5SWH DI	2 464.18	5.5
NISO100-65-250/7.5SWH	2 411.02	NISO100-65-250/7.5SWS	2 836.22	NISO100-65-250/7.5SWH DI	2 584.71	7.5
NISO100-65-315/11SWH	3 132.74	NISO100-65-315/11SWS	3 443.41	NISO100-65-315/11SWH DI	3 358.31	11
NISO100-65-315/15SWH	3 283.60	NISO100-65-315/15SWS	3 603.16	NISO100-65-315/15SWH DI	3 519.89	15
NISO100-80-160/1.5SWH	1 519.04	NISO100-80-160/1.5SWS	1 714.64	NISO100-80-160/1.5SWH DI	1 628.23	1.5
NISO100-80-160/2.2SWH	1 614.48	NISO100-80-160/2.2SWS	1 815.72	NISO100-80-160/2.2SWH DI	1 730.60	2.2
NISO100-80-160/3SWH	1 668.79	NISO100-80-160/3SWS	1 873.36	NISO100-80-160/3SWH DI	1 789.29	3
NISO125-100-200/4SWH	1 999.21	NISO125-100-200/4SWS	2 307.13	NISO125-100-200/4SWH DI	2 143.61	4
NISO125-100-200/5.5SWH	2 312.96	NISO125-100-200/5.5SWS	2 639.26	NISO125-100-200/5.5SWH DI	2 479.75	5.5
NISO125-100-200/7.5SWH	2 421.77	NISO125-100-200/7.5SWS	2 754.50	NISO125-100-200/7.5SWH DI	2 596.14	7.5
NISO125-100-200/11SWH	2 702.82	NISO125-100-200/11SWS	3 052.57	NISO125-100-200/11SWH DI	2 897.48	11
NISO125-100-250/15SWH	3 317.31	NISO125-100-250/15SWS	3 825.30	NISO125-100-250/15SWH DI	3 556.25	15
NISO125-100-315/11SWH	3 296.94	NISO125-100-315/11SWS	3 872.95	NISO125-100-315/11SWH DI	3 533.91	11
NISO125-100-315/18.5SWH	3 847.91	NISO125-100-315/18.5SWS	4 457.06	NISO125-100-315/18.5SWH DI	4 125.14	18.5
NISO125-100-315/22SWH	3 992.69	NISO125-100-315/22SWS	4 610.57	NISO125-100-315/22SWH DI	4 280.48	22
NISO125-100-315/30SWH	4 823.27	NISO125-100-315/30SWS	5 490.68	NISO125-100-315/30SWH DI	5 170.46	30
NISO125-80-400/15SWH	3 563.18	NISO125-80-400/15SWS	5 076.90	NISO125-80-400/15SWH DI	3 819.65	15
NISO125-80-400/18.5SWH	3 969.10	NISO125-80-400/18.5SWS	5 538.85	NISO125-80-400/18.5SWH DI	4 255.03	18.5
NISO125-80-400/22SWH	4 152.77	NISO125-80-400/22SWS	5 747.59	NISO125-80-400/22SWH DI	4 451.41	22
NISO125-80-400/30SWH	5 024.72	NISO125-80-400/30SWS	6 740.67	NISO125-80-400/30SWH DI	5 386.59	30
NISO125-80-400/37SWH	5 425.60	NISO125-80-400/37SWS	7 197.00	NISO125-80-400/37SWH DI	5 816.76	37
NISO125-100-400/30SWH	5 172.40	NISO125-100-400/30SWS	5 806.64	NISO125-100-400/30SWH DI	5 544.52	30
NISO125-100-400/37SWH	5 536.96	NISO125-100-400/37SWS	7 333.16	NISO125-100-400/37SWH DI	5 935.74	37
NISO125-100-400/45SWH	6 475.61	NISO125-100-400/45SWS	8 401.09	NISO125-100-400/45SWH DI	6 941.56	45
NISO150-125-250/22SWH	4 072.80	NISO150-125-250/22SWS	4 623.14	NISO150-125-250/22SWH DI	4 366.20	22
NISO150-125-250/18.5SWH	3 925.24	NISO150-125-250/18.5SWS	4 471.73	NISO150-125-250/18.5SWH DI	4 207.76	18.5
NISO150-125-250/15SWH	3 551.26	NISO150-125-250/15SWS	4 075.69	NISO150-125-250/15SWH DI	3 807.19	15
NISO150-125-250/11SWH	3 388.80	NISO150-125-250/11SWS	3 903.36	NISO150-125-250/11SWH DI	3 632.62	11
NISO150-125-315/37SWH	5 657.93	NISO150-125-315/37SWS	6 788.30	NISO150-125-315/37SWH DI	6 065.62	37
NISO150-125-315/30SWH	5 325.88	NISO150-125-315/30SWS	6 436.25	NISO150-125-315/30SWH DI	5 709.21	30
NISO150-125-400/75SWH	9 055.11	NISO150-125-400/75SWS	10 347.46	NISO150-125-400/75SWH DI	9 707.08	75
NISO150-125-400/55SWH	7 682.18	NISO150-125-400/55SWS	8 892.14	NISO150-125-400/55SWH DI	8 235.22	55
NISO150-125-400/45SWH	6 907.03	NISO150-125-400/45SWS	8 070.72	NISO150-125-400/45SWH DI	7 403.97	45
NISO200-150-315/75SWH	9 748.95	NISO200-150-315/75SWS	11 209.22	NISO200-150-315/75SWH DI	10 015.11	75
NISO200-150-315/55SWH	8 431.83	NISO200-150-315/55SWS	9 813.13	NISO200-150-315/55SWH DI	8 661.82	55
NISO200-150-315/45SWH	7 655.34	NISO200-150-315/45SWS	8 990.63	NISO200-150-315/45SWH DI	7 864.71	45
NISO200-150-315/37SWH	6 883.95	NISO200-150-315/37SWS	8 173.42	NISO200-150-315/37SWH DI	7 072.57	37
NISO200-150-400/110SWH	16 683.47	NISO200-150-400/110SWS	19 049.46	NISO200-150-400/110SWH DI	17 139.44	110
NISO200-150-400/90SWH	11 025.08	NISO200-150-400/90SWS	13 053.25	NISO200-150-400/90SWH DI	11 326.56	90
NISO200-150-400/75SWH	10 207.13	NISO200-150-400/75SWS	12 186.75	NISO200-150-400/75SWH DI	10 486.60	75
NISO250-200-315/37SWH	8 074.90	NISO250-200-315/37SWS	8 860.33	NISO250-200-315/37SWH DI	7 760.25	37
NISO250-200-315/45SWH	8 939.98	NISO250-200-315/45SWS	9 709.92	NISO250-200-315/45SWH DI	8 591.25	45
NISO250-200-315/55SWH	9 751.90	NISO250-200-315/55SWS	10 507.36	NISO250-200-315/55SWH DI	9 371.28	55
NISO250-200-315/75SWH	11 208.73	NISO250-200-315/75SWS	11 938.16	NISO250-200-315/75SWH DI	10 771.68	75
NISO250-200-400/90SWH	12 647.96	NISO250-200-400/90SWS	13 566.23	NISO250-200-400/90SWH DI	12 154.41	90
NISO250-200-400/110SWH	18 565.26	NISO250-200-400/110SWS	19 377.86	NISO250-200-400/110SWH DI	17 841.18	110
NISO250-200-400/132SWH	18 790.48	NISO250-200-400/132SWS	19 599.04	NISO250-200-400/132SWH DI	18 057.16	132
NISO250-200-400/160SWH	20 289.99	NISO250-200-400/160SWS	21 071.80	NISO250-200-400/160SWH DI	19 498.71	160
NISO300-250-315(Q)/75SWH	\	NISO300-250-315(Q)/75SWS	\	NISO300-250-315(Q)/75SWH DI	13 726.80	75
NISO300-250-315(Q)/90SWH	\	NISO300-250-315(Q)/90SWS	\	NISO300-250-315(Q)/90SWH DI	14 745.11	90
NISO300-250-315(Q)/110SWH	\	NISO300-250-315(Q)/110SWS	\	NISO300-250-315(Q)/110SWH DI	21 175.84	110
NISO300-250-315/75SWH	\	NISO300-250-315/75SWS	\	NISO300-250-315/75SWH DI	13 726.80	75
NISO300-250-315/90SWH	\	NISO300-250-315/90SWS	\	NISO300-250-315/90SWH DI	14 745.11	90
NISO300-250-315/110SWH	\	NISO300-250-315/110SWS	\	NISO300-250-315/110SWH DI	21 175.84	110
NISO300-250-400/132SWH	\	NISO300-250-400/132SWS	\	NISO300-250-400/132SWH DI	22 768.22	132

NIS0300-250-400/160SWH	\	NIS0300-250-400/160SWS	\	NIS0300-250-400/160SWH DI	24 491.57	160
NIS0300-250-400/200SWH	\	NIS0300-250-400/200SWS	\	NIS0300-250-400/200SWH DI	25 977.22	200
NIS0300-250-400(Q)/110SWH	\	NIS0300-250-400(Q)/110SWS	\	NIS0300-250-400(Q)/110SWH DI	22 421.09	110
NIS0300-250-400(Q)/132SWH	\	NIS0300-250-400(Q)/132SWS	\	NIS0300-250-400(Q)/132SWH DI	22 768.22	132
NIS0300-250-400(Q)/160SWH	\	NIS0300-250-400(Q)/160SWS	\	NIS0300-250-400(Q)/160SWH DI	24 491.57	160
NIS0300-250-400(Q)/200SWH	\	NIS0300-250-400(Q)/200SWS	\	NIS0300-250-400(Q)/200SWH DI	25 977.22	200



ZS центробежные моноблочные штампованные насосы

Материал изготовления нержавеющей сталь SS304.

обновление 25.04.2022

Модель	Артикул	Цена розница (USD) с НДС
ZS50-32-160/1.1	ZS50-32-160/1.1SSC	921.11
ZS50-32-160/1.5	ZS50-32-160/1.5SSC	997.34
ZS50-32-160/2.2	ZS50-32-160/2.2SSC	1 039.27
ZS50-32-200/3	ZS50-32-200/3SSC	1 279.39
ZS50-32-200/4	ZS50-32-200/4SSC	1 483.94
ZS50-32-200/5.5	ZS50-32-200/5.5SSC	1 842.23
ZS65-40-125/1.5	ZS65-40-125/1.5SSC	1 024.02
ZS65-40-125/2.2	ZS65-40-125/2.2SSC	1 074.84
ZS65-40-125/3	ZS65-40-125/3SSC	1 330.21
ZS65-40-160/4	ZS65-40-160/4SSC	1 534.76
ZS65-40-200/5.5	ZS65-40-200/5.5SSC	1 893.05
ZS65-40-200/7.5	ZS65-40-200/7.5SSC	1 929.89
ZS65-40-200/11	ZS65-40-200/11SSC	2 272.92
ZS65-50-125/3	ZS65-50-125/3SSC	1 381.03
ZS65-50-125/4	ZS65-50-125/4SSC	1 585.58
ZS65-50-160/5.5	ZS65-50-160/5.5SSC	1 943.87
ZS65-50-200/7.5	ZS65-50-200/7.5SSC	1 994.69
ZS65-50-200/9.2	ZS65-50-200/9.2SSC	2 046.78

Модель	Артикул	Цена розница (USD) с НДС
ZS65-50-200/11	ZS65-50-200/11SSC	2 251.33
ZS65-50-200/15	ZS65-50-200/15SSC	2 403.79
ZS65-50-200/18.5	ZS65-50-200/18.5SSC	2 557.52
ZS80-65-125/5.5	ZS80-65-125/5.5SSC	2 106.49
ZS80-65-125/7.5	ZS80-65-125/7.5SSC	2 150.96
ZS80-65-125/9.2	ZS80-65-125/9.2SSC	2 319.93
ZS80-65-160/11	ZS80-65-160/11SSC	2 895.47
ZS80-65-160/15	ZS80-65-160/15SSC	3 078.42
ZS80-65-200/18.5	ZS80-65-200/18.5SSC	3 333.79
ZS80-65-200/22	ZS80-65-200/22SSC	4 154.54
ZS80-65-200/30	ZS80-65-200/30SSC	5 310.69
ZS100-80-160/11	ZS100-80-160/11SSC	2 892.93
ZS100-80-160/15	ZS100-80-160/15SSC	3 075.88
ZS100-80-160/18.5	ZS100-80-160/18.5SSC	3 224.53
ZS100-80-200/22	ZS100-80-200/22SSC	4 249.82
ZS100-80-200/30	ZS100-80-200/30SSC	5 408.52
ZS100-80-200/37	ZS100-80-200/37SSC	5 826.51

Насосные агрегаты комплектуются двигателями с классом защиты IP55 в стандартном исполнении (по цене агрегата с двигателем IP54)!!!

* Цена насосов ZS из нержавеющей стали SS316 +30% к цене из SS304.



MS горизонтальные одноступенчатые центробежные насосы из нержавеющей стали

Цены указаны на насосные агрегаты из нержавеющей стали **SS304**. Стоимость агрегата из **SS316 +30%** к цене соотв. модели.

обновление 25.04.2022

3*380V		1*220V		Мощность (кВт)
Артикул	Розница USD с НДС	Артикул	Розница USD с НДС	
MS60/0,75SSC	377.23	MS60/0,75DSC	415.60	0.75
MS60/0,55SSC	306.48	MS60/0,55DSC	335.45	0.55
MS60/0,37SSC	281.58	MS60/0,37DSC	310.55	0.37
MS100/1,1SSC	441.19	MS100/1,1DSC	495.10	1.1
MS100/0,55SSC	301.76	MS100/0,55DSC	330.73	0.55
MS160/1,1SSC	443.91	MS160/1,1DSC	499.13	1.1
MS160/0,75SSC	375.20	MS160/0,75DSC	414.95	0.75
MS250/2,2SSC	537.53	MS250/2,2DSC	577.93	2.2
MS250/1,5SSC	501.85	MS250/1,5DSC	552.34	1.5
MS250/1,1SSC	441.88	MS250/1,1DSC	497.13	1.1
MS330/2,2SSC	537.53	MS330/2,2DSC	577.28	2.2
MS330/1,5SSC	501.85	MS330/1,5DSC	552.34	1.5



SZ горизонтальные одноступенчатые фторопластовые центробежные насосы



обновление 25.04.2022

Фторопласт F26		Фторопласт F46		Мощность (кВт)
Артикул	Роница USD с НДС	Артикул	Роница USD с НДС	
SZ 25-25-125SF26	1 546.24	SZ 25-25-125SF46	1 932.79	1.1
SZ 40-25-125SF26	1 621.27	SZ 40-25-125SF46	2 026.60	1.5
SZ 50-32-125SF26	2 036.36	SZ 50-32-125SF46	2 545.46	3
SZ 50-32-160SF26	2 460.88	SZ 50-32-160SF46	3 076.11	4
SZ 65-50-125SF26	2 525.23	SZ 65-50-125SF46	3 156.54	4
SZ 65-50-160SF26	3 107.72	SZ 65-50-160SF46	3 884.66	5.5
SZ 80-65-125SF26	3 225.77	SZ 80-65-125SF46	4 032.21	7.5
SZ 65-40-200SF26	4 245.85	SZ 65-40-200SF46	5 307.31	11
SZ 80-65-160SF26	4 113.98	SZ 80-65-160SF46	5 142.48	11
SZ 80-50-200SF26	4 808.40	SZ 80-50-200SF46	6 010.51	18.5

Насосные агрегаты комплектуются двигателями с классом защиты IP55 в стандартном исполнении (по цене агрегата с двигателем IP54)!

WLT высокоэффективные высокорасходные насосы

WLT S 100-5 A / 2.2 S W S



обновление 25.04.2022

N	Модель/артикул	Мощность, кВт	Q, м3/ч	H, м.вод.ст.	Скорость, об/мин	Цена розница, USD с НДС
1	WLT65-5/1.1SWS	1.1	40	5	2900	667.54
2	WLT80-5/1.5SWS	1.5	55	5	2900	799.54
3	WLT100-5A/2.2SWS	2.2	80	5	1450	1 245.22
4	WLT100-5/2.2SWS	2.2	100	5	1450	1 245.22
5	WLT125-5A/3SWS	3	120	5	1450	1 436.27
6	WLT125-5/4SWS	4	160	5	1450	1 669.88
8	WLT150-6A/5.5SWS	5.5	200	6	1450	2 367.78
9	WLT150-6/7.5SWS	7.5	250	6	1450	2 449.13
WLTS - с удлиненным валом						
10	WLTS65-5/1.1SWS	1.1	40	5	2900	721.81
11	WLTS80-5/1.5SWS	1.5	55	5	2900	865.49
12	WLTS100-5A/2.2SWS	2.2	80	5	1450	1 316.86
13	WLTS100-5/2.2SWS	2.2	100	5	1450	1 316.86
14	WLTS125-5A/3SWS	3	120	5	1450	1 506.31
16	WLTS125-5/4SWS	4	160	5	1450	1 745.97
17	WLTS150-6A/5.5SWS	5.5	200	6	1450	2 486.79
18	WLTS150-6/7.5SWS	7.5	250	6	1450	2 578.29
WLTSF - с удлиненным валом, проточная часть из нерж.стали						
19	WLTSF65-5/1.1SWS	1.1	40	5	2900	2 242.00
20	WLTSF65-5/1.1SWS	1.1	40	5	2900	2 242.00
21	WLTSF65-5/1.1SWS	1.1	40	5	2900	2 242.00
22	WLTSF80-5/1.5SWS	1.5	55	5	2900	2 360.10
23	WLTSF100-5A/2.2SWS	2.2	80	5	1450	3 245.70
24	WLTSF100-5/2.2SWS	2.2	120	5	1450	3 245.70
25	WLTSF125-5A/3SWS	3	150	5	1450	3 658.43
26	WLTSF125-5/4SWS	4	180	5	1450	4 012.36
27	WLTSF150-6A/5.5SWS	5.5	220	6	1450	5 664.67
28	WLTSF150-6/7.5SWS	7.5	250	6	1450	6 136.67

Стоимость насосов указана на стандартное исполнение: корпус - чугун; рабочее колесо SS304, двигатель 380В.

Для насосов с однофазным двигателем цена насосов рассчитывается следующим образом: 1.1кВт -32,46 USD, 1.5кВт-46,38 USD, 2.2кВт-55,7 USD

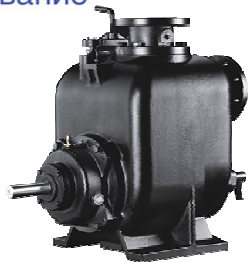

SP самовсасывающие поверхностные насосы для отвода загрязненных сточных вод

обновление 25.04.2022

Модель	Мощность		Рабочее колесо - нерж. ст. SS304		Рабочее колесо - чугун	
	Серия	(кВт)	Артикул	Цена розница (USD) с НДС	Артикул	Цена розница (USD) с НДС
SP-2(1150)	4	1.1	SP-2MSHRC(1150)	4 654.36	SP-2MQHRC(1150)	4 292.12
SP-2(1450)*	4	1.5	SP-2MSHRC(1450)*	4 745.41	SP-2MQHRC(1450)*	4 383.16
SP-2(1750)	2	3	SP-2MSHRC(1750)	5 022.80	SP-2MQHRC(1750)	4 660.55
SP-2(2050)	2	4.0	SP-2MSHRC(2050)	5 155.21	SP-2MQHRC(2050)	4 792.97
SP-2(2350)	2	7.5	SP-2MSHRC(2350)	5 524.63	SP-2MQHRC(2350)	5 162.38
SP-2(2650)	2	7.5	SP-2MSHRC(2650)	5 527.96	SP-2MQHRC(2650)	5 165.72
SP-2(2900)*	2	9.2	SP-2MSHRC(2900)*	5 712.28	SP-2MQHRC(2900)*	5 350.04

Модель	Мощность		Рабочее колесо - нерж. ст. SS304		Рабочее колесо - чугун	
	Серия	(кВт)	Артикул	Цена розница (USD) с НДС	Артикул	Цена розница (USD) с НДС
SP-3(650)	4	0.75	SP-3MSHRC(650)	5 381.98	SP-3MQHRC(650)	4 983.51
SP-3(750)*	8	1.5	SP-3MSHRC(750)*	5 791.48	SP-3MQHRC(750)*	5 393.01
SP-3(850)	4	1.5	SP-3MSHRC(850)	5 482.12	SP-3MQHRC(850)	5 083.65
SP-3(950)*	6	1.5	SP-3MSHRC(950)*	5 645.64	SP-3MQHRC(950)*	5 247.17
SP-3(1050)	4	3.0	SP-3MSHRC(1050)	5 725.52	SP-3MQHRC(1050)	5 327.05
SP-3(1150)	4	4.0	SP-3MSHRC(1150)	5 869.65	SP-3MQHRC(1150)	5 471.18
SP-3(1250)	4	4.0	SP-3MSHRC(1250)	5 888.91	SP-3MQHRC(1250)	5 490.44
SP-3(1350)	4	5.5	SP-3MSHRC(1350)	6 260.47	SP-3MQHRC(1350)	5 862.00
SP-3(1450)	4	5.5	SP-3MSHRC(1450)	6 085.12	SP-3MQHRC(1450)	5 686.65
SP-3(1550)	2	7.5	SP-3MSHRC(1550)	6 282.95	SP-3MQHRC(1550)	5 884.48
SP-3(1650)	2	11.0	SP-3MSHRC(1650)	6 793.95	SP-3MQHRC(1650)	6 395.48
SP-3(1750)	2	11.0	SP-3MSHRC(1750)	6 804.08	SP-3MQHRC(1750)	6 405.61
SP-3(1850)	2	15.0	SP-3MSHRC(1850)	7 142.33	SP-3MQHRC(1850)	6 743.86
SP-3(1950)	2	15.0	SP-3MSHRC(1950)	7 092.51	SP-3MQHRC(1950)	6 694.04
SP-3(2050)	2	18.5	SP-3MSHRC(2050)	7 355.94	SP-3MQHRC(2050)	6 957.47
SP-3(2150)	2	18.5	SP-3MSHRC(2150)	7 449.85	SP-3MQHRC(2150)	7 051.38

Модель	Мощность		Рабочее колесо - нерж. ст. SS304		Рабочее колесо - чугун	
	Серия	(кВт)	Артикул	Цена розница (USD) с НДС	Артикул	Цена розница (USD) с НДС
SP-4(650)	4	1.5	SP-4MSHRC(650)	5 941.27	SP-4MQHRC(650)	5 506.57
SP-4(750)*	8	1.5	SP-4MSHRC(750)*	6 327.74	SP-4MQHRC(750)*	5 893.05
SP-4(850)	4	2.2	SP-4MSHRC(850)	6 064.58	SP-4MQHRC(850)	5 629.89
SP-4(950)*	6	3.0	SP-4MSHRC(950)*	6 597.95	SP-4MQHRC(950)*	6 163.25
SP-4(1050)	4	5.5	SP-4MSHRC(1050)	6 594.28	SP-4MQHRC(1050)	6 159.59
SP-4(1150)	4	5.5	SP-4MSHRC(1150)	6 634.48	SP-4MQHRC(1150)	6 199.79
SP-4(1250)	4	7.5	SP-4MSHRC(1250)	6 830.58	SP-4MQHRC(1250)	6 395.89
SP-4(1350)	4	11.0	SP-4MSHRC(1350)	7 396.92	SP-4MQHRC(1350)	6 962.23
SP-4(1450)*	4	11.0	SP-4MSHRC(1450)*	7 190.44	SP-4MQHRC(1450)*	6 755.75
SP-4(1550)	2	15.0	SP-4MSHRC(1550)	7 726.95	SP-4MQHRC(1550)	7 292.25
SP-4(1650)	2	18.5	SP-4MSHRC(1650)	7 863.51	SP-4MQHRC(1650)	7 428.82
SP-4(1750)	2	22.0	SP-4MSHRC(1750)	8 413.85	SP-4MQHRC(1750)	7 979.16
SP-4(1850)	2	30.0	SP-4MSHRC(1850)	10 190.81	SP-4MQHRC(1850)	9 756.11
SP-4(1950)	2	30.0	SP-4MSHRC(1950)	10 633.67	SP-4MQHRC(1950)	10 198.97

Модель	Мощность		Рабочее колесо - нерж. ст. SS304		Рабочее колесо - чугун	
	Серия	(кВт)	Артикул	Цена розница (USD) с НДС	Артикул	Цена розница (USD) с НДС
SP-6(650)	4	3.0	SP-6MSHRC(650)	6 966.78	SP-6MQHRC(650)	6 495.87
SP-6(750)*	8	4.0	SP-6MSHRC(750)*	8 339.39	SP-6MQHRC(750)*	7 868.47
SP-6(850)	4	7.5	SP-6MSHRC(850)	8 018.39	SP-6MQHRC(850)	7 547.47
SP-6(950)*	6	7.5	SP-6MSHRC(950)*	8 390.17	SP-6MQHRC(950)*	7 919.25
SP-6(1050)	4	11.0	SP-6MSHRC(1050)	8 429.73	SP-6MQHRC(1050)	7 958.81
SP-6(1150)	4	15.0	SP-6MSHRC(1150)	8 832.07	SP-6MQHRC(1150)	8 361.15
SP-6(1250)	4	22.0	SP-6MSHRC(1250)	10 520.55	SP-6MQHRC(1250)	10 049.63
SP-6(1350)	4	30.0	SP-6MSHRC(1350)	12 099.62	SP-6MQHRC(1350)	11 628.70
SP-6(1450)*	4	30.0	SP-6MSHRC(1450)*	10 442.42	SP-6MQHRC(1450)*	9 971.50
SP-6(1550)	4	37.0	SP-6MSHRC(1550)	12 625.92	SP-6MQHRC(1550)	12 155.00

Модель	Мощность		Рабочее колесо - нерж. ст. SS304		Рабочее колесо - чугун	
	Серия	(кВт)	Артикул	Цена розница (USD) с НДС	Артикул	Цена розница (USD) с НДС
SP-8(650)	6	7.5	SP-8MSHRC(650)	---	SP-8MQHRC(650)	16 599.22
SP-8(750)*	8	11	SP-8MSHRC(750)*	---	SP-8MQHRC(750)*	16 829.04
SP-8(850)	6	15	SP-8MSHRC(850)	---	SP-8MQHRC(850)	18 048.49
SP-8(950)*	6	22	SP-8MSHRC(950)*	---	SP-8MQHRC(950)*	17 994.48
SP-8(1050)	4	30	SP-8MSHRC(1050)	---	SP-8MQHRC(1050)	20 251.45
SP-8(1150)	4	37	SP-8MSHRC(1150)	---	SP-8MQHRC(1150)	21 104.11
SP-8(1250)	4	55	SP-8MSHRC(1250)	---	SP-8MQHRC(1250)	23 527.14
SP-8(1350)	4	75	SP-8MSHRC(1350)	---	SP-8MQHRC(1350)	25 646.32
SP-8(1450)*	4	75	SP-8MSHRC(1450)*	---	SP-8MQHRC(1450)*	22 232.70

Модель	Мощность		Рабочее колесо - нерж. ст. SS304		Рабочее колесо - чугун	
	Серия	(кВт)	Артикул	Цена розница (USD) с НДС	Артикул	Цена розница (USD) с НДС
SP-10(650)	6	11	SP-1MSHRC(650)	---	SP-1MQHRC(650)	19 029.48
SP-10(750)*	8	15	SP-1MSHRC(750)*	---	SP-1MQHRC(750)*	19 791.68
SP-10(850)	6	22	SP-1MSHRC(850)	---	SP-1MQHRC(850)	21 884.22
SP-10(950)*	6	30	SP-1MSHRC(950)*	---	SP-1MQHRC(950)*	21 437.25
SP-10(1050)	4	45	SP-1MSHRC(1050)	---	SP-1MQHRC(1050)	24 270.61
SP-10(1150)	4	55	SP-1MSHRC(1150)	---	SP-1MQHRC(1150)	25 802.57
SP-10(1250)	4	75	SP-1MSHRC(1250)	---	SP-1MQHRC(1250)	27 931.01
SP-10(1350)	4	90	SP-1MSHRC(1350)	---	SP-1MQHRC(1350)	28 714.19
SP-10(1450)*	4	90	SP-1MSHRC(1450)*	---	SP-1MQHRC(1450)*	25 401.31

SP насосная часть

Модель	Рабочее колесо - нерж. ст. SS304		Рабочее колесо - чугун	
	Артикул	Цена розница (USD) с НДС	Артикул	Цена розница (USD) с НДС
SP-2	SP-2MSHRC	3 369.85	SP-2MQHRC	3 016.66
SP-3	SP-3MSHRC	3 907.92	SP-3MQHRC	3 519.41
SP-4	SP-4MSHRC	4 257.50	SP-4MQHRC	3 833.67
SP-6	SP-6MSHRC	5 172.65	SP-6MQHRC	4 713.50
SP-8	SP-8MSHRC	-	SP-8MQHRC	11 304.79
SP-10	SP-10MSHRC	14 052.44	SP-10MQHRC	13 312.20



QY/QYL – Самовсасывающие вихревые насосы-ФЛОТАТОРЫ из нержавеющей стали 50HZ

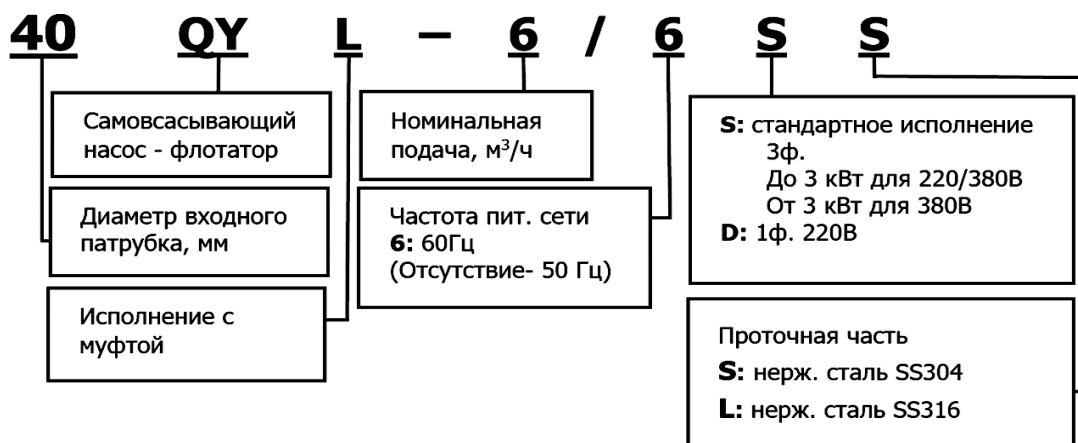

обновление 25.04.2022

Модель/Арт.	Мощность, кВт	Цена розница, USD с НДС
20QY-1SS	0.55	901.22
25QY-2SS	1.1	1 094.34
40QY-6SS	3	1 931.16
50QY-12SS	5.5	3 218.62

20QYL-1SS	0.55	1 622.17
25QYL-2SS	1.1	1 969.78
40QYL-6SS	4	3 540.44
50QYL-12SS	7.5	6 179.71

С каталогом и руководством по эксплуатации необходимо ознакомиться на сайте оф. представительства

<https://www.cnprussia.ru/catalog/qy-qyl.html>



Трехфазные асинхронные двигатели (низковольтные)

Примечание: Цена указана для двигателей типа **B3**; класс защиты **IP55**

Цена двигателей типа **B5, B14**+2% от цены **B3**, **B35, V1** (до типоразмера 160) +5%, (выше типоразмера 160) +3%, **V15** +7%.

Подготовка двигателя под установку датчиков +2% к стоимости.

обновление 02.06.2022

Модель YE2 (IE2, IP55, GB3, IC411)

Модель/Арт.	Мощность, кВт	Ток, А	Частота, об/мин	КПД, %	Р.Ф.	Момент, Н·м	T_{st}/T_N	T_{max}/T_N	I_{st}/I_N	Цена розн., USD с НДС
2-х полюсные. 3000 об/мин - 50 Гц										
YE2-80M1-2	0.75	1.8	2855	77.4	0.82	2.4	2.3	2.3	6.8	166.12
YE2-80M2-2	1.1	2.5	2860	79.6	0.83	3.5	2.3	2.3	7.1	180.41
YE2-90S-2	1.5	3.3	2890	81.3	0.84	4.8	2.3	2.3	7.3	213.48
YE2-90L-2	2.2	4.7	2890	83.2	0.85	7	2.3	2.3	7.6	241.56
YE2-100L-2	3	6.2	2880	84.6	0.87	9.6	2.2	2.3	7.8	326.23
YE2-112M-2	4	8	2910	85.8	0.88	12.7	2.2	2.3	8.1	404.41
YE2-132S1-2	5.5	10.9	2905	87	0.88	17.5	2.2	2.3	8.2	544.98
YE2-132S2-2	7.5	14.5	2915	88.1	0.89	23.9	2.2	2.3	7.8	612.63
YE2-160M1-2	11	21	2935	89.4	0.89	35	2.2	2.3	7.9	943.63
YE2-160M2-2	15	28.4	2935	90.3	0.89	47.8	2.2	2.3	7.9	1 083.02
YE2-160L-2	18.5	34.7	2935	90.9	0.89	58.9	2.2	2.3	8	1 229.71
YE2-180M-2	22	41.1	2950	91.3	0.89	70	2.2	2.3	8.1	1 561.72
YE2-200L1-2	30	55.7	2960	92	0.89	95.5	2	2.3	7.5	2 085.77
YE2-200L2-2	37	68.3	2960	92.5	0.89	118	2	2.3	7.5	2 329.52
YE2-225M-2	45	82.7	2965	92.9	0.89	143	2.2	2.3	7.5	2 991.45
YE2-250M-2	55	100.7	2970	93.2	0.89	175	2.2	2.3	7.6	3 546.49
YE2-280S-2	75	136.5	2975	93.8	0.89	239	1.8	2.3	6.9	4 386.13
YE2-280M-2	90	163.3	2975	94.1	0.89	287	1.8	2.3	6.9	4 937.12
YE2-315S-2	110	197	2975	94.3	0.9	350	1.8	2.2	7	8 572.31
YE2-315M-2	132	236	2975	94.6	0.9	420	1.8	2.2	7	9 212.00
YE2-315L1-2	160	282	2975	94.8	0.91	509	1.8	2.2	7.1	10 370.36
YE2-315L-2	185	325	2975	95	0.91	589	1.8	2.2	7.1	12 103.50
YE2-315L2-2	200	352	2975	95	0.91	637	1.8	2.2	7.1	11 647.59
YE2-355M1-2	220	387	2980	95	0.91	700	1.6	2.2	7.1	16 952.57
YE2-355M2-2	250	439	2980	95	0.91	796	1.6	2.2	7.1	18 781.38
YE2-355L1-2	280	492	2980	95	0.91	891	1.6	2.2	7.1	19 180.25
YE2-355L2-2	315	554	2980	95	0.91	1003	1.6	2.2	7.2	20 908.01
YE2-3551-2	355	624	2980	95	0.91	1130	1.6	2.2	7.2	по запросу
YE2-3552-2	375	659	2980	95	0.91	1194	1.6	2.2	7.2	
4-х полюсные. 1500 об/мин - 50 Гц										
YE2-80M1-4	0.55	1.5	1415	77.1	0.75	3.5	2.3	2.3	6.4	158.61
YE2-80M2-4	0.75	1.9	1415	79.6	0.76	4.8	2.3	2.3	6.4	172.14
YE2-90S-4	1.1	2.7	1425	81.4	0.77	7	2.3	2.3	6.6	206.72
YE2-90L-4	1.5	3.5	1425	82.8	0.78	9.6	2.3	2.3	6.7	233.54

YE2-100L1-4	2.2	5	1440	84.3	0.8	14	2.3	2.3	7.3	307.44
YE2-100L2-4	3	6.6	1440	85.5	0.81	19.1	2.3	2.3	7.5	343.74
YE2-112M-4	4	8.7	1445	86.6	0.81	25.5	2.3	2.3	7.5	422.55
YE2-132S-4	5.5	11.6	1455	87.7	0.82	35	2	2.3	7.5	571.29
YE2-132M-4	7.5	15.5	1455	88.7	0.83	47.8	2	2.3	7.3	656.82
YE2-160M-4	11	22.4	1465	89.8	0.83	70	2	2.3	7.4	996.91
YE2-160L-4	15	30	1465	90.6	0.84	95.5	2	2.3	7.5	1 171.33
YE2-180M-4	18.5	36.3	1470	91.2	0.85	118	2	2.3	7.6	1 479.30
YE2-180L-4	22	42.9	1470	91.6	0.85	140	2.1	2.3	7.7	1 620.15
YE2-200L-4	30	58.1	1475	92.3	0.85	191	2.1	2.3	7.1	2 163.85
YE2-225S-4	37	70.5	1480	92.7	0.86	236	2.1	2.3	7.3	2 658.66
YE2-225M-4	45	85.4	1480	93.1	0.86	287	2.2	2.3	7.3	2 957.15
YE2-250M-4	55	104	1480	93.5	0.86	350	2.2	2.3	7.3	3 487.71
YE2-280S-4	75	139	1485	94	0.87	478	2.2	2.3	6.8	4 434.26
YE2-280M-4	90	165	1485	94.2	0.88	573	2.2	2.3	6.9	5 052.40
YE2-315S-4	110	199	1485	94.5	0.89	700	2.1	2.2	6.9	8 137.99
YE2-315M-4	132	238	1485	94.7	0.89	840	2.1	2.2	6.9	9 145.84
YE2-315L1-4	160	285	1485	94.9	0.9	1019	2.1	2.2	6.9	10 508.67
YE2-315L-4	185	328	1485	95.1	0.9	1178	2.1	2.2	6.9	11 509.92
YE2-315L2-4	200	355	1485	95.1	0.9	1273	2.1	2.2	6.9	11 882.59
YE2-355M1-4	220	391	1490	95.1	0.9	1401	2	2.2	6.8	16 337.28
YE2-355M2-4	250	444	1490	95.1	0.9	1592	2	2.2	6.8	16 809.46
YE2-355L1-4	280	497	1490	95.1	0.90 t	1783	2	2.2	6.8	17 935.54
YE2-355L2-4	315	559	1490	95.1	0.9	2006	2	2.2	6.8	18 839.03
YE2-3551-4	355	637	1490	95.1	0.89	2260	1.7	2.2	6.5	по запросу
YE2-3552-4	375	681	1490	95.1	0.88 1	2388	1.7	2.2	6.5	
6-ти полюсные. 1000 об/мин - 50 Гц										
YE2-80M1-6	0.37	1.3	900	62	0.7	3.5	1.9	2	4.7	159.83
YE2-80M2-6	0.55	1.8	900	65	0.72	5.3	1.9	2.1	4.7	175.88
YE2-90S-6	0.75	2.1	940	75.9	0.71	7.2	2	2.1	5.8	210.47
YE2-90L-6	1.1	3	940	78.1	0.72	10.5	2	2.1	5.9	243.75
YE2-100L-6	1.5	4	950	79.8	0.72	14.3	2	2.1	5.9	314.21
YE2-112M-6	2.2	5.7	955	81.8	0.72	21	2	2.1	6.2	393.14
YE2-132S-6	3	7.6	970	83.3	0.72	28.7	2	2.1	6.4	521.67
YE2-132M1-6	4	9.7	970	84.6	0.74	38.2	2	2.1	6.6	600.60
YE2-132M2-6	5.5	13	970	86	0.75	52.5	2	2.1	6.8	676.52
YE2-160M-6	7.5	16.8	975	87.2	0.78	71.6	2	2.1	6.8	949.39
YE2-160L-6	11	23.9	975	88.7	0.79	105	2	2.1	6.9	1 147.97
YE2-180L-6	15	31	980	89.7	0.82	143	2	2.1	7.3	1 492.44
YE2-200L1-6	18.5	38.9	980	90.4	0.8	177	2	2.1	7.2	1 846.16
YE2-200L2-6	22	45.4	980	90.9	0.81	210	2	2.1	7.3	1 998.92
YE2-225M-6	30	60.6	985	91.7	0.82	287	2	2.1	6.8	2 618.52
YE2-250M-6	37	73.5	985	92.2	0.83	353	2	2.1	7	3 197.70
YE2-280S-6	45	86.8	990	92.7	0.85	430	2	2	7.2	3 973.45
YE2-280M-6	55	104	990	93.1	0.86	525	2	2	7.2	4 535.72
YE2-315S-6	75	145	990	93.7	0.84	716	2	2	6.5	8 188.19
YE2-315M-6	90	171	990	94	0.85	860	2	2	6.6	9 052.43
YE2-315L1-6	110	209	990	94.1	0.85	1051	2	2	6.6	10 313.52
YE2-315L2-6	132	247	990	94.7	0.86	1261	2	2	6.6	11 276.85
YE2-355M1-6	160	298	990	94.8	0.86	1528	2	2	6.7	15 509.68
YE2-355M2-6	185	344	990	94.9	0.86	1767	2	2	6.7	16 111.03
YE2-355M3-6	200	372	990	95	0.86	1910	2	2	6.8	16 840.18
YE2-355L1-6	220	409	990	95	0.86	2101	2	2	6.8	17 820.76
YE2-355L2-6	250	465	990	95	0.86	2388	2	2	6.8	20 861.30
YE2-355L4-6	280	492	990	95	0.91	2674	2	2	6.8	29 317.20
YE2-3552-6	315	586	990	95	0.86	3008	2	2	6.8	29 915.51
YE2-3553-6	355	660	990	95	0.86	3390	2	2	6.8	по запросу

8-ми полюсные. 750 об/мин - 50 Гц										
YE2-132S-8	2.2	6	705	77.6	0.71	28	1.8	2	6	552.49
YE2-132M-8	3	7.9	705	80	0.73	38.2	1.8	2	6	631.28
YE2-160M1-8	4	10.3	720	81.9	0.73	50.9	1.9	2	6	848.66
YE2-160M2-8	5.5	13.6	720	83.8	0.74	70	2	2	6	932.85
YE2-160L-8	7.5	17.8	720	85.3	0.75	95.5	2	2	6.6	1 092.51
YE2-180L-8	11	25.1	730	86.9	0.76	140	2	2	6.6	1 462.79
YE2-200L-8	15	34.1	730	88	0.76	191	2	2	6.6	2 086.86
YE2-225S-8	18.5	41.1	730	88.6	0.76	236	1.9	2	6.6	2 346.79
YE2-225M-8	22	47.4	730	89.1	0.78	280	1.9	2	6.6	2 547.73
YE2-250M-8	30	63.4	730	89.8	0.79	382	1.9	2	6.6	3 408.16
YE2-280S-8	37	77.8	730	90.3	0.81	471	1.9	2	6.6	4 299.98
YE2-280M-8	45	94.1	740	90.7	0.81	573	1.9	2	6.6	4 834.19
YE2-315S-8	55	113	740	91	0.82	700	2	2	6.6	7 572.55
YE2-315M-8	75	154	740	91.6	0.82	955	2	2	6.6	8 937.12
YE2-315L1-8	90	182	740	91.9	0.82	1146	2	2	6.6	10 126.81
YE2-315L2-8	110	221	740	92.3	0.82	1401	2	2	6.6	11 094.24
YE2-355M1-8	132	264	740	92.6	0.82	1681	2	2	6.6	14 688.83
YE2-355M2-8	160	319	740	93	0.82	2037	2	2	6.7	17 488.90
YE2-355L-8	200	392	740	93.5	0.83	2547	2	2	6.8	18 802.85
YE2-3551-8	220	431	740	93.5	0.83	2801	2	2	6.8	по запросу
YE2-3552-8	250	490	740	93.5	0.83	3183	2	2	6.8	
10-ти полюсные. 600 об/мин - 50 Гц										
YE2-315S-10	45	101	594	90.2	0.75	716	2	2	7.2	7 900.29
YE2-315M-10	55	123	594	90.5	0.75	875	2	2	7.2	8 677.54
YE2-315L1-10	75	165	594	91.1	0.76	1194	2	2	6.5	11 797.20
YE2-315L2-10	90	194	594	91.4	0.77	1433	2	2	6.6	по запросу
YE2-355M1-10	110	233	590	91.8	0.78	1751	2	2	6.6	
YE2-355M2-10	132	279	590	92.1	0.78	2101	2	2	6.6	
YE2-355L-10	160	337	590	92.5	0.78	2547	2	2	6.7	
YE2-3551-10	185	390	590	92.5	0.78	2945	2	2	6.7	
YE2-3552-10	200	421	590	92.5	0.78	3183	2	2	6.8	

Модель YE3 (IE3, IP55, GB2, IC411)

2-х полюсные. 3000 об/мин - 50 Гц										
YE3-80M1-2	0.75	1.7	2885	80.7	0.82	2.4	2.3	2.3	7	234.64
YE3-80M2-2	1.1	2.4	2885	82.7	0.83	3.5	2.2	2.3	7.3	263.98
YE3-90S-2	1.5	3.2	2905	84.2	0.84	4.8	2.2	2.3	7.6	327.53
YE3-90L-2	2.2	4.6	2905	85.9	0.85	7	2.2	2.3	7.6	381.30
YE3-100L-2	3	6	2895	87.1	0.87	9.6	2.2	2.3	7.8	469.29
YE3-112M-2	4	7.8	2915	88.1	0.88	12.7	2.2	2.3	8.3	586.62
YE3-132S1-2	5.5	10.6	2925	89.2	0.88	17.5	2	2.3	8.3	791.93
YE3-132S2-2	7.5	14.4	2925	90.1	0.88	23.9	2	2.3	7.8	938.59
YE3-160M 1-2	11	20.6	2950	91.2	0.89	35	2	2.3	8.1	1 495.88
YE3-160M2-2	15	27.9	2950	91.9	0.89	47.8	2	2.3	8.1	1 666.97
YE3-160L-2	18.5	34.2	2950	92.4	0.89	58.9	2	2.3	8.2	1 877.17
YE3-180M-2	22	40.5	2960	92.7	0.89	70	2	2.3	8.2	2 581.12
YE3-200L1-2	30	54.9	2965	93.3	0.89	95.5	2	2.3	7.6	2 991.75
YE3-200L2-2	37	67.4	2965	93.7	0.89	118	2	2.3	7.6	3 285.05
YE3-225M-2	45	80.8	2965	94	0.9	143	2	2.3	7.7	3 813.01
YE3-250M-2	55	98.5	2970	94.3	0.9	175	2	2.3	7.7	4 751.59
YE3-280S-2	75	134	2975	94.7	0.9	239	1.8	2.3	7.1	6 951.42
YE3-280M-2	90	160	2975	95	0.9	287	1.8	2.3	7.1	7 626.01
YE3-315S-2	110	195	2980	95.2	0.9	350	1.8	2.3	7.1	12 318.96

YE3-315M-2	132	234	2980	95.4	0.9	420	1.8	2.3	7.1	13 404.19
YE3-315L1-2	160	279	2980	95.6	0.91	509	1.8	2.3	7.2	14 372.12
YE3-315L2-2	200	349	2980	95.8	0.91	637	1.8	2.2	7.2	15 428.03
YE3-355M-2	250	436	2985	95.8	0.91	796	1.6	2.2	7.2	25 077.88
YE3-355L-2	315	549	2985	95.8	0.91	1003	1.6	2.2	7.2	26 984.39
YE3-3551-2	355	619	2985	95.8	0.91	1130	1.6	2.2	7.2	по запросу
YE3-3552-2	375	654	2985	95.8	0.91	1194	1.6	2.2	7.2	
4-х полюсные. 1500 об/мин - 50 Гц										
YE3-80M2-4	0.75	1.8	1435	82.5	0.75	4.8	2.3	2.3	6.6	263.98
YE3-90S-4	1.1	2.6	1435	84.1	0.76	7	2.3	2.3	6.8	351.97
YE3-90L-4	1.5	3.5	1435	85.3	0.77	9.6	2.3	2.3	7	410.63
YE3-100L1-4	2.2	4.8	1450	86.7	0.81	14	2.3	2.3	7.6	527.96
YE3-100L2-4	3	6.3	1450	87.7	0.82	19.1	2.3	2.3	7.6	586.62
YE3-112M-4	4	8.4	1455	88.6	0.82	25.5	2.2	2.3	7.8	703.93
YE3-132S-4	5.5	11.2	1465	89.6	0.83	35	2	2.3	7.9	967.91
YE3-132M-4	7.5	15	1465	90.4	0.84	47.8	2	2.3	7.5	1 143.90
YE3-160M-4	11	21.5	1470	91.4	0.85	70	2.2	2.3	7.7	1 525.20
YE3-160L-4	15	28.8	1470	92.1	0.86	95.5	2.2	2.3	7.8	1 847.85
YE3-180M-4	18.5	35.3	1475	92.6	0.86	118	2	2.3	7.8	2 346.47
YE3-180L-4	22	41.8	1475	93	0.86	140	2	2.3	7.8	2 581.12
YE3-200L-4	30	56.6	1475	93.6	0.86	191	2	2.3	7.3	3 255.72
YE3-225S-4	37	69.6	1480	93.9	0.86	236	2	2.3	7.4	3 896.11
YE3-225M-4	45	84.4	1480	94.2	0.86	287	2	2.3	7.4	4 223.65
YE3-250M-4	55	103	1485	94.6	0.86	350	2.2	2.3	7.4	5 220.90
YE3-280S-4	75	136	1485	95	0.88	478	2	2.3	6.9	7 391.37
YE3-280M-4	90	163	1485	95.2	0.88	573	2	2.3	6.9	8 300.63
YE3-315S-4	110	197	1485	95.4	0.89	700	2	2.2	7	12 788.25
YE3-315M-4	132	236	1485	95.6	0.89	840	2	2.2	7	14 284.13
YE3-315L1-4	160	285	1485	95.8	0.89	1019	2	2.2	7.1	15 076.05
YE3-315L2-4	200	352	1485	96	0.9	1273	2	2.2	7.1	16 806.57
YE3-355M-4	250	440	1490	96	0.9	1592	2	2.2	7.1	23 670.00
YE3-355L-4	315	554	1490	96	0.9	2006	2	2.2	7.1	26 984.39
YE3-3551-4	355	638	1490	96	0.88	2260	1.7	2.2	7	по запросу
YE3-3552-4	375	674	1490	96	0.88	2388	1.7	2.2	7	
6-ти полюсные. 1000 об/мин - 50 Гц										
YE3-90S-6	0.75	2	950	78.9	0.71	7.2	2	2.1	6	351.97
YE3-90L-6	1.1	2.8	950	81	0.73	10.5	2	2.1	6	410.63
YE3-100L-6	1.5	3.8	960	82.5	0.73	14.3	2	2.1	6.5	469.29
YE3-112M-6	2.2	5.4	960	84.3	0.74	21	2	2.1	6.6	645.28
YE3-132S-6	3	7.2	970	85.6	0.74	28.7	2	2.1	6.8	762.61
YE3-132M1-6	4	9.5	970	86.8	0.74	38.2	2	2.1	6.8	909.26
YE3-132M2-6	5.5	12.7	970	88	0.75	52.5	2	2.1	7	1 055.91
YE3-160M-6	7.5	16.2	975	89.1	0.79	71.6	2	2.1	7	1 437.22
YE3-160L-6	11	23.1	975	90.3	0.8	105	2	2.1	7.2	1 730.52
YE3-180L-6	15	30.9	980	91.2	0.81	143	2	2.1	7.3	2 317.14
YE3-200L1-6	18.5	37.8	980	91.7	0.81	177	2	2.1	7.3	2 786.43
YE3-200L2-6	22	44.8	980	92.2	0.81	210	2	2.1	7.4	3 050.41
YE3-225M-6	30	59.1	985	92.9	0.83	287	2	2.1	6.9	3 695.68
YE3-250M-6	37	71.7	985	93.3	0.84	353	2	2.1	7.1	4 516.95
YE3-280S-6	45	85.8	990	93.7	0.85	430	2	2	7.3	6 042.16
YE3-280M-6	55	103	990	94.1	0.86	525	2	2	7.3	6 746.09
YE3-315S-6	75	143	990	94.6	0.84	716	2	2	6.6	10 852.41
YE3-315M-6	90	170	990	94.9	0.85	860	2	2	6.7	11 849.66
YE3-315L1-6	110	207	990	95.1	0.85	1051	2	2	6.7	13 105.99
YE3-315L2-6	132	245	990	95.4	0.86	1261	2	2	6.8	14 342.79
YE3-355M1-6	160	296	990	95.6	0.86	1528	1.8	2	6.8	21 059.54
YE3-355M2-6	200	365	990	95.8	0.87	1910	1.8	2	6.8	23 464.67
YE3-355L-6	250	456	990	95.8	0.87	2388	1.8	2	6.8	26 691.07

Комплектующие для мониторинга состояния

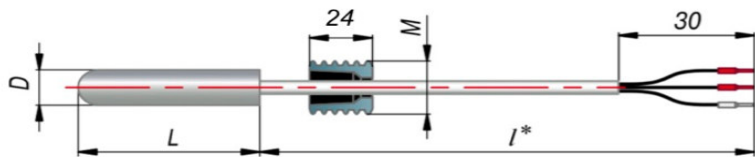
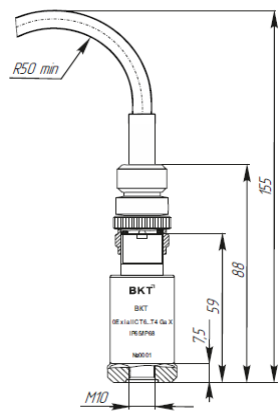
Модель	Артикул	Цена розн., USD с НДС
<p>Датчик температуры PT100 (ДТС034Э2-РТ100.В3.25/1,5) (Э2-штулка резьбовая длиной 24 мм)</p>  <p>Модель ДТС034Э2-РТ100.В3.25/1,5 Э2 - штулка резьбовая длиной 24мм D=5 мм, M=8x1 мм, L=25 мм, l=1,5 м</p>	--	100
<p>Вибропреобразователь ВКТ-10 СКЗ виброскорости 0-30 мм/с. Частотный диапазон 10-1000 Гц. Выходной сигнал 4-20мА (токовая петля). Разъем MIL-2 (вилка)</p> 	--	1100
<p>в комплекте: Шпилька монтажная M10x1/M8x1,0</p>	--	
<p>в комплекте: Кабельная сборка 1,5 метра</p>	--	
<p>Магнитное основание ВКТ-10 (на плоскость и цилиндрическую поверхность)</p>	--	150



Системы автоматизации Aikon **НОВОЕ ПОКОЛЕНИЕ**

обновление 08.07.2022

Модель	PD ES	PD E	PD SS
Возможность одновременной работы нескольких насосов в режиме PBS	Да (до 6 насосов)	Нет (только через контролер)	Нет
Диапазон мощностей	1.5 - 560 кВт	1.5 - 560 кВт	0.75 - 2.2 кВт
Питание ЧП	3x380В	3x380В	1x220В
Питание двигателей	3x380В	3x380В	3x220В
Степень защиты	IP 20/IP 65	IP 20	IP 65

С контролерами серии PD ES IP65 мощностью до 7.5 кВт включительно поставляется пластина для установки на клеммную коробку и вводной автомат, до 22 кВт включительно только вводной автомат. Свыше 30 кВт включительно в комплект поставки входит только контролер.

Мощность двигателя насоса, кВт	Ток, А	PD ES IP20		PD ES IP65		PD E IP20	
		Артикул	Цена розница, USD с НДС	Артикул	Цена розница, USD с НДС	Артикул	Цена розница, USD с НДС
1.5	3.7	PD ES 1.5 IP20	311.30	PD ES 1.5 IP65	522.45	PD E 1.5 IP20	295.74
2.2	5	PD ES 2.2 IP20	335.50	PD ES 2.2 IP65	537.63	PD E 2.2 IP20	318.73
4	8.5	PD ES 4 IP20	404.80	PD ES 4 IP65	714.73	PD E 4 IP20	384.56
5.5	13	PD ES 5.5 IP20	481.80	PD ES 5.5 IP65	770.39	PD E 5.5 IP20	457.71
7.5	18	PD ES 7.5 IP20	530.20	PD ES 7.5 IP65	786.83	PD E 7.5 IP20	503.69
11	24	PD ES 11 IP20	819.50	PD ES 11 IP65	1 082.84	PD E 11 IP20	778.53
15	30	PD ES 15 IP20	962.50	PD ES 15 IP65	1 163.80	PD E 15 IP20	914.38
18.5	37	PD ES 18.5 IP20	1 134.10	PD ES 18.5 IP65	1 195.43	PD E 18.5 IP20	1077.40
22	46	PD ES 22 IP20	1 346.40	PD ES 22 IP65	1 813.90	PD E 22 IP20	1279.08
30	58	PD ES 30 IP20	1 611.50	PD ES 30 IP65	2 105.40	PD E 30 IP20	1530.93
37	75	PD ES 37 IP20	1 974.50	PD ES 37 IP65	2 369.40	PD E 37 IP20	1875.78
45	90	PD ES 45 IP20	2 406.80	PD ES 45 IP65	2 888.16	PD E 45 IP20	2286.46
55	110	PD ES 55 IP20	2 929.30	PD ES 55 IP65	3 515.16	PD E 55 IP20	2782.84
75	150	PD ES 75 IP20	4 017.20	PD ES 75 IP65	4 820.64	PD E 75 IP20	3816.34
90	170	PD ES 90 IP20	4 550.70	PD ES 90 IP65	5 460.84	PD E 90 IP20	4323.17
110	210	PD ES 110 IP20	5 865.20	PD ES 110 IP65	7 038.24	PD E 110 IP20	5571.94
132	250	PD ES 132 IP20	7 452.50	PD ES 132 IP65	8 943.00	PD E 132 IP20	7079.88
160	300	PD ES 160 IP20		PD ES 160 IP65		PD E 160 IP20	
185	340	PD ES 185 IP20		PD ES 185 IP65		PD E 185 IP20	
200	380	PD ES 200 IP20		PD ES 200 IP65		PD E 200 IP20	
220	430	PD ES 220 IP20		PD ES 220 IP65		PD E 220 IP20	
250	465	PD ES 250 IP20		PD ES 250 IP65		PD E 250 IP20	
280	520	PD ES 280 IP20		PD ES 280 IP65		PD E 280 IP20	
315	585	PD ES 315 IP20		PD ES 315 IP65		PD E 315 IP20	
355	650	PD ES 355 IP20		PD ES 355 IP65		PD E 355 IP20	
400	754	PD ES 400 IP20		PD ES 400 IP65		PD E 400 IP20	
450	850	PD ES 450 IP20		PD ES 450 IP65		PD E 450 IP20	
500	930	PD ES 500 IP20		PD ES 500 IP65		PD E 500 IP20	
560	1050	PD ES 560 IP20		PD ES 560 IP65		PD E 560 IP20	

PD SS (220)

Мощность двигателя, кВт	Артикул	Ток вход/выход, А	Цена розница, USD с НДС
0.75	PS SS 0.75	9/4,5	251.90

1.5	PS SS 1.5	14/7	258.50
2.2	PS SS 2.2	20/10	269.50

Принадлежности для контролеров	Артикул	Цена розница, USD с НДС
Сенсорная панель управления PD H диагональ 7 дюймов	PD H 7	330
Сенсорная панель управления PD H диагональ 10 дюймов	PD H 10	491.7
Контролер PD P	PD P	330
Система контроля состояния PD C (для передачи информации с датчиков в облачный сервер)	PD C	440
Модуль связи PD G (для подключения к облачному серверу контролеров PD R)	PD G	269.5
Датчик дифференциального давления SPD , перепад давления макс 3 Атм, , 4...20 мА, +24 В, резьба 2xG1/4", без кабеля погрешность 0,5%.	SPD 0-3bar	330
Датчик дифференциального давления SPD , перепад давления макс 6 Атм, , 4...20 мА, +24 В, резьба 2xG1/4", без кабеля погрешность 0,5%.	SPD 0-6bar	330
Датчик давления SP100 , 0...6 Атм, двухпроводный, 4...20 мА, +24 В, резьба G1/4", длина кабеля 1,5 м, погрешность 0,5%.	SP100 0-6bar	56.10
Датчик давления SP100 , 0...10 Атм, двухпроводный, 4...20 мА, +24 В, резьба G1/4", длина кабеля 1,5 м, погрешность 0,5%.	SP100 0-10bar	56.10
Датчик давления SP100 , 0...16 Атм, двухпроводный, 4...20 мА, +24 В, резьба G1/4", длина кабеля 1,5 м, погрешность 0,5%.	SP100 0-16bar	56.10
Датчик давления SP100 , 0...25 Атм, двухпроводный, 4...20 мА, +24 В, резьба G1/4", длина кабеля 1,5 м, погрешность 0,5%.	SP100 0-25bar	70.20
Плата расширения RS2 для создания второго выхода MODBUS для PD	--	37.40



Входные дроссели (сетевые)				Выходные дроссели (моторные)			
Модель/арт.	Мощность	Ток, А	Цена розница, USD с НДС	Модель/арт.	Мощность	Ток, А	Цена розница, USD с НДС
ETOCL-00030-ALU2100-4L	0.75	3	129.56	ETACL-00037-ALM840-4L	0.75	3.7	78.75
ETOCL-00050-ALU2000-4L	1.5	5	139.09	ETACL-00050-ALM420-4L	1.5	5	84.00
ETOCL-00065-ALU1500-4L	2.2	6.3	161.32	ETACL-00075-ALM300-4L	2.2	7.5	107.25
ETOCL-0011-ALU1200-4L	4	11	196.88	ETACL-0010-ALM220-4L	3.7	10	148.50
ETOCL-0016-ALU900-4L	5.5	16	245.78	ETACL-0015-ALM142-4L	5.5	15	270.75
ETOCL-0020-ALU700-4L	7.5	20	264.84	ETACL-0020-ALM108-4L	7.5	20	290.25
ETOCL-0030-ALU650-4L	11	30	294.05	ETACL-0030-ALM70-4L	11	30	312.75

ETOCL-0040-ALU600-4L	15	40	339.78	ETACL-0040-ALM53-4L	15	40	324.00
ETOCL-0050-ALU450-4L	18.5	50	365.18	ETACL-0050-ALM42-4L	18.5	50	347.25
ETOCL-0060-ALU350-4L	22	60	403.92	ETACL-0060-ALM36-4L	22	60	389.25
ETOCL-0080-ALU100-4L	30	80	444.57	ETACL-0080-ALM26-4L	30	80	420.00
ETOCL-0100-ALU90-4L	37	100	471.88	ETACL-0100-ALM24-4L	37	100	458.25
ETOCL-0120-ALU80-4L	45	100	507.44	ETACL-0120-ALM18-4L	45	120	549.75
ETOCL-0150-ALU65-4L	55	150	541.74	ETACL-0150-ALM15-4L	55	150	610.50
ETOCL-0200-ALU40-4L	75	200	568.41	ETACL-0200-ALM11-4L	75	200	750.00
ETOCL-0230-ALU35-4L	90	230	646.53	ETACL-0230-ALM10-4L	90	230	824.25
ETOCL-0250-ALU30-4L	110	250	678.29	ETACL-0250-ALM09-4L	110	250	877.50
ETOCL-0280-ALU25-4L	132	280	759.58	ETACL-0280-ALM08-4L	132	280	1049.25
ETOCL-0330-ALU20-4L	160	330	936.77	ETACL-0330-ALM06-4L	160	330	1125.00
ETOCL-0360-ALU16-4L	187	360	1018.07	ETACL-0360-ALM05-4L	187	360	1182.75
ETOCL-0400-ALU13-4L	200	400	1066.33	ETACL-0400-ALM045-4L	200	400	1259.25
ETOCL-0450-ALU11-4L	220	450	1131.11	ETACL-0450-ALM04-4L	220	450	1374.00
ETOCL-0500-ALU09-4L	250	500	1224.47	ETACL-0500-ALM03-4L	250	500	1564.50
ETOCL-0600-ALU07-4L	280	600	1260.04	ETACL-0600-ALM025-4L	280	600	1641.00
ETOCL-0650-ALU06-4L	315	650	1373.72	ETACL-0650-ALM022-4L	315	650	1728.75
ETOCL-0750-ALU055-4L	400	750	1607.44	ETACL-0750-ALM02-4L	400	750	1946.25
ETOCL-1000-ALU045-4L	500	1000	2410.20	ETACL-1000-ALM019-4L	500	1000	2900.25
ETOCL-1250-ALU035-4L	630	1250	3004.66	ETACL-1180-ALM015-4L	630	1180	3624.75
ETOCL-1400-ALU025-4L	710	1400	3315.22	ETACL-1400-ALM012-4L	710	1400	4006.50
ETOCL-1600-ALU015-4L	800	1600	3877.29	ETACL-1600-ALM010-4L	800	1600	4960.50

РАСПРОДАЖА складских остатков!!! Контроллеры с регулированием частоты серий PDM, PD R

обновление
25.04.2022

Технические характеристики:

Модель	PD R	PDM
Питание	3x380В	1x220В
Подключение двигателя	3x380В	3x220В
Кол-во подключаемых насосов (интеллектуальное управление)	До 6 по шине RS485, релейно до 3 со сменой мастера	нет
Накладная установка на клемную коробку двигателя	да	да
Степень защиты	IP55	IP65/55
Кол-во дискретных входов	6	2
Кол-во аналоговых входов (0-20мА, 4-20 мА, 0-10 В, 2-10 В)	2	1
Кол-во релейных выходов	6	0
Количество аналоговых выходов (0-20мА, 4-20 мА, 0-10 В, 2-10 В)	0	0
Настройка через Bluetooth	нет	нет
Функция поддержания перепада давления по 2 датчикам давления	да	нет
Кол-во портов RS485 (Modbus)*	2(опция до 4)	нет





*При задании работы интеллектуальной функции управления насосной станцией по шине RS485 используется один из портов контроллера.

Мощность двигателя насоса, кВт	Цена розница, USD с НДС					
	PD R РАСПРОДАЖА складских остатков!!!	Ток, А	Артикул	PDM(220)	Ток вход/выход, А	Артикул
0.75	-----	2.7	-----	229.00	9/4,5	PDM 0.75
1.5	382.46	4	PD R 1.5	235.00	14/7	PDM 1.5
2.2	390.75	5	PD R 2.2	245.00	20/10	PDM 2.2
4	510.96	8.6	PD R 4	-----		-----
5.5	510.96	12.5	PD R 5.5	-----		-----
7.5	СНЯТ	17.5	PD R 7.5	-----		-----
11	834.68	24	PD R 11	-----		-----
15	840.18	33	PD R 15	-----		-----
18.5	1 008.04	40	PD R 18.5	-----		-----
22	СНЯТ	47	PD R 22	-----		-----
30	СНЯТ	65	PD R 30	-----		-----

ЗАПОРНАЯ АРМАТУРА Aikon

обновление 25.04.2022

Дисковый поворотный затвор Aikon IMB037			
Артикул	Диаметр, мм	Описание	Цена розн., USD с НДС
IMB037 DN40	DN40	Макс. рабочее давление: 16 бар, рабочая температура: до 110 град.С, Корпус- чугун; диск- ковкий чугун, уплотнение – EPDM; шток – нерж. сталь. Начиная с DN200 с редуктором.	50.24
IMB037 DN50	DN50		48.52
IMB037 DN65	DN65		59.30
IMB037 DN80	DN80		65.37
IMB037 DN100	DN100		75.01
IMB037 DN125	DN125		89.41
IMB037 DN150	DN150		105.03
IMB037 DN200	DN200		274.05
IMB037 DN250	DN250		350.72
IMB037 DN300	DN300		471.43
IMB037 DN350	DN350		623.73
IMB037 DN400	DN400		1 003.38
IMB037 DN450	DN450		1 255.18
IMB037 DN500	DN500		1 583.92
IMB037 DN600	DN600		2 860.09
IMB037 DN700	DN700		4 980.42
IMB037 DN800	DN800	5 730.90	
IMB037 DN900	DN900	9 156.00	
IMB037 DN1000	DN1000	11 141.62	
IMB037 DN1200	DN1200	17 738.56	
			
Обратный клапан межфланцевый Aikon IMC021			
Артикул	Диаметр, мм	Описание	Цена розн., USD с НДС
IMC021 DN40	DN40	Макс. рабочее давление: 16 бар, рабочая температура: 70- 120 град.С, Корпус, пластины- ковкий чугун, уплотнение – EPDM, шток и пружина – нерж. сталь	31.72
IMC021 DN50	DN50		36.33
IMC021 DN65	DN65		46.71
IMC021 DN80	DN80		66.90
IMC021 DN100	DN100		85.35
IMC021 DN125	DN125		107.84
IMC021 DN150	DN150		144.18
IMC021 DN200	DN200		226.64
IMC021 DN250	DN250		365.63
IMC021 DN300	DN300		484.43
IMC021 DN350	DN350		934.62
IMC021 DN400	DN400		1 381.25
IMC021 DN450	DN450		1 846.30
IMC021 DN500	DN500		2 389.66
IMC021 DN600	DN600		3 717.24
IMC021 DN700	DN700		7 434.91
IMC021 DN800	DN800	10 089.95	
			

Задвижка с обрезиненным клином Aikop IMR001

Артикул	Диаметр, мм	Описание	Цена розн., USD с НДС
IMR001 DN40	DN40	Макс. рабочее давление: 16 бар, рабочая температура: до 110 град.С, Корпус- ковкий чугун; диск- ковкий чугун +EPDM, уплотнение – NBR, EPDM	98.96
IMR001 DN50	DN50		100.46
IMR001 DN65	DN65		126.30
IMR001 DN80	DN80		147.94
IMR001 DN100	DN100		178.08
IMR001 DN125	DN125		252.84
IMR001 DN150	DN150		279.70
IMR001 DN200	DN200		461.04
IMR001 DN250	DN250		723.72
IMR001 DN300	DN300		1 015.89
IMR001 DN350	DN350		1 849.52
IMR001 DN400	DN400		2 278.39
IMR001 DN450	DN450		3 591.81
IMR001 DN500	DN500		4 020.69
IMR001 DN600	DN600		6 929.52
IMR001 DN700	DN700	15 600.26	



Фильтр фланцевый Aikop IMS024

Артикул	Диаметр, мм	Описание	Цена розн., USD с НДС
IMS024 DN50	DN50	Макс. рабочее давление: 16 бар, рабочая температура: до 110 град.С, Корпус и крышка - ковкий чугун, прокладка крышки- EPDM	95.42
IMS024 DN65	DN65		127.05
IMS024 DN80	DN80		149.03
IMS024 DN100	DN100		195.14
IMS024 DN125	DN125		287.88
IMS024 DN150	DN150		376.87
IMS024 DN200	DN200		663.68
IMS024 DN250	DN250		1 028.76
IMS024 DN300	DN300		1 489.26



Обратный клапан шаровый Aikop IMC017 (для канализации)

Артикул	Диаметр, мм	Описание	Цена розн., USD с НДС
IMC017 DN50	DN50	Макс. рабочее давление: 16 бар, Корпус, крышка- ковкий чугун, шар-	92.21
IMC017 DN65	DN65		119.01
IMC017 DN80	DN80		147.96
IMC017 DN100	DN100		182.27
IMC017 DN125	DN125		338.81
IMC017 DN150	DN150		461.57
IMC017 DN200	DN200		731.76
IMC017 DN250	DN250		1 245.34
IMC017 DN300	DN300		1 654.38



Антивибрационная вставка Aikon IMX

Артикул	Диаметр, мм	Описание	Цена розн., USD с НДС	
			1.0MPa	1.6MPa
IMX DN25	DN25	Макс. рабочее давление: 16 бар, фланцы: сталь SS; виброгасящая вставка: NR, EPDM, CR, NBR, FDM, IIR	34.63	34.63
IMX DN32	DN32		34.63	34.63
IMX DN40	DN40		38.81	38.81
IMX DN50	DN50		42.40	42.40
IMX DN65	DN65		54.94	54.94
IMX DN80	DN80		63.89	63.89
IMX DN100	DN100		78.22	78.22
IMX DN125	DN125		112.86	112.86
IMX DN150	DN150		137.94	137.94
IMX DN200	DN200		216.16	216.16
IMX DN250	DN250		291.40	341.56
IMX DN300	DN300		351.12	415.61
IMX DN350	DN350		493.83	536.23
IMX DN400	DN400		642.52	696.26
IMX DN450	DN450		784.04	852.71
IMX DN500	DN500		1 003.19	1 110.07
IMX DN600	DN600		1 191.28	1 373.41
IMX DN700	DN700		1 442.08	1 755.58
IMX DN800	DN800		1 849.92	2 351.52
IMX DN900	DN900		2 445.27	3 103.91
IMX DN1000	DN1000	2 965.97	3 761.95	
IMX DN1200	DN1200	3 950.05	5 454.83	
IMX DN1400	DN1400	5 223.14	0.00	

